



AKSARBEN

Sign & Graphic Supplies

 Roland

Nebraska's original
Roland Dealer



NESCHEN



2010 DIGITAL CATALOG

Go to our website for latest prices and special deals

SignAndGraphicSupplies.com

800-646-6064

Over 22 years in the Industry



- Digital Media
- Lamination
- Equipment
- Ink & Parts
- Services
- Custom Banners
- Vinyl
- Apparel Transfer
- Sign Supplies
- Tapes
- Displays
- Software & Fills
- LEDs
- Electrical
- Substrates

Founded in 1988, Matt Rusek started Aksarben Sign & Graphic Supplies when screen-printed banners were the hot sauce in advertising. Eventually Matt grew the company to include custom blank banners, pressure sensitive vinyl and application tape. Boy, things seemed simple back then. Next came the inkjet printers, which came in like a storm. The company grew and stays ahead of the curve in an industry that is always changing and improving. You can count on us to give you the latest in sign and banner technology at a reasonable price and hometown customer service.

Aksarben Sign & Graphic Supplies • 3319 Nebraska Avenue • Council Bluffs, IA 51501

Find It Fast

- Digital Media** 3-14..... Banner, Vinyl, Films
- Lamination** 15-19..... Equipment, Film, Liquid Laminate
- Equipment** 20-25..... Printers, Printer/Cutters, Cutters, Engravers
- Ink & Parts** 26-30..... Inks, Consumables
- Services** 31-33..... Roland Printer & Cutter Repair, Custom Converting & Sewing, Grommeting
- Custom Banners** 34-35..... Custom Colors & Sizes
- Vinyl** 36-40..... Cast, Calendered, Special PSVinyls
- Apparel Transfer** 41-43..... Solid Color, Printable Transfer Media
- Sign Supplies** 44-49... Gobbs of tools to get the job done right
- Tapes** 50-51..... Application, Surface Protection, UHB, Foam, Masking, Hem
- Displays** 52-61..... Banner & Trade Show, A-Frame, Yard Sign, Pole Brackets
- Software & Fills** 62-67..... Design, RIP, Fills, Vector, Vehicle Templates
- LEDs** 68..... Channel Letter, Architectural
- Electrical** 69-70..... Ballasts, Transformers
- Substrates** 71-73..... Corrugate, PVC, Aluminum, Wood, Solid & Corrugated Core Aluminum Boards

Hot Items

This symbol is sprinkled throughout the catalog, it indicates popular items given "two thumbs up" by our customers. Here are some favorite hotties:

- Aurora Graphics – Wrapture 62
- Banner Ups 49
- ClearJet Liquid Laminate 15
- ColorPrint – for textiles 42
- Corrugated Sign Blanks..... 72
- Digital Knight – Clamshell 43
- LED Lighting 68
- LG Xign 7
- MacTac Street Rap 12
- Magnetic Printable Media..... 12
- Plasticade – Marquee..... 52
- Retractable Banner Stands 59
- Roland Printers 20-23
- SignComp RTS – post & panel..... 58
- ThermoFlex..... 41

LOOK FOR THIS SYMBOL



Introducing Matt Zarben:
If you see him, take note, as he has something important to say.

Green Products



Help Aksarben Sign & Graphic Supplies save trees and reduce waste, by bookmarking or downloading the electronic catalog. Peruse the catalog onscreen (search using PDF's search engine) or view it on our website – www.SignAndGraphicSupplies.com. Print only the pages you need!

A note about color in this catalog:

Please note that the color swatches in this catalog are limited by the 4 color printing process, and that it would be impossible to match the actual colors without using spot colors, which would be really expensive...so please appreciate the time we spent trying our best to make the colors as close as we could, and be happy when your red is actually **brighter** and more vibrant than the swatch you saw while ordering. :o) And if you're printing this catalog from a PDF, for the love of Pete, don't forget to get your color management. Thank you!

Digital Media A wide variety of types

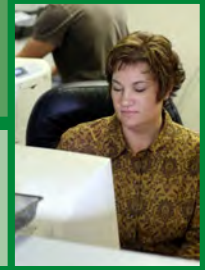

We carry a huge variety of media. Need something you don't see here? Give us a call, or check our website for products not seen here:

www.SignAndGraphicSupplies.com.

Banner Material Roland

20mil Blockout Scrim Banner

This premium-quality two-sided blackout 20 oz. scrim banner uncoated vinyl has a smooth surface for superior printing on either side. It can be hemmed and grommeted, and the high tenacity polyester base cloth makes it extremely dimensionally stable for a wide variety of indoor and outdoor applications. This Roland product is certified flame retardant.

ESM-BOSB-66-54...54" x 66ft.....\$1.04/ft².....\$307.99

18mil Blockout Banner Vinyl

This double-sided 19 oz. uncoated scrim banner vinyl is a great all-purpose banner product for solvent ink printing a variety of indoor and long-term outdoor applications (up to 3 years outdoors). It is a high-quality coated banner (versus laminated banner) with a great white point, and can be hemmed and grommeted to finish, and wind slit as well.

ESM-BBV-66-54 .54" x 66ft .. \$0.78/ft²..\$231.99

14mil Light Weight Banner Vinyl

This single-sided 13 oz. uncoated scrim banner vinyl is a great all-purpose banner product for solvent ink printing a variety of indoor and long-term outdoor applications (up to 3 years outdoors). It is a high-quality coated banner (versus laminated banner) that is very flexible with a great white point, and can be hemmed and grommeted to finish, and wind slit as well.

ESM-LBV-66-3030" x 66ft.....\$0.58/ft².....\$95.99

ESM-LBV-66-5454" x 66ft.....\$0.58/ft².....\$171.99

14mil Premium Glossy Reinforced Banner

This premium-quality 14 mil glossy scrim banner vinyl was specially prepared for our solvent inks. It can be hemmed and grommeted and offers a waterproof solution for outdoor applications (depending on weather and environmental conditions and the specifics of mounting). Large banners displayed outdoors should be tested for wind resistance depending on the required durability and longevity of the application.

SCM-SPVCB-66-50 .50" x 66ft.....\$1.07/ft².....\$294.39

18mil Flame Retardant Scrim Banner

This premium-quality one-sided 16 oz. scrim banner uncoated vinyl is specially treated and certified flame retardant. It has a high tensile strength, is tear resistant, and is perfect for both indoor and outdoor applications. It is dimensionally stable and can be hemmed and grommeted for a superb finished look. Large banners displayed outdoors should be tested for wind resistance depending on the required durability and longevity of the application.

ESM-FRSB-66-54 ...54" x 66ft.....\$0.86/ft².....\$255.99



Adhesive Backed Vinyl Roland

3mil Clear Calendered Vinyl (ESL only)

This new improved version of our high-quality 3 mil clear adhesive-back uncoated vinyl has an optically clear adhesive and a clear polyethylene liner. It's designed for many types of graphic applications, including use as an overlaminated film. It is excellent for application to regular surfaces, and prints are durable both laminated and unlaminated, although lamination is recommended for protection against abrasion and chemical deterioration. If used as an overlaminated film, pressure is all that is required for adhesion.

ESM-CCV2-75-30...30" x 75ft.....\$0.27/ft².....\$51.59

3mil Clear Calendered Vinyl (EX)

This high-quality 3 mil clear adhesive-back uncoated vinyl is designed for many types of graphic applications. It images nicely in a variety of print modes and has a permanent adhesive. It is excellent for application to regular surfaces, and durable both laminated and unlaminated, although lamination is recommended for protection against abrasion and chemical deterioration.

ESM-CCVP-75-30...30" x 75ft.....\$0.33/ft².....\$63.99

ESM-CCVP-75-54...54" x 75ft.....\$0.33/ft².....\$111.99



CONTINUED ON NEXT PAGE

Adhesive Backed Vinyl (con't)



3mil Glossy Calendered

This high-quality 3 mil glossy adhesive-back uncoated vinyl is designed for many types of graphic applications. It images nicely in a variety of print modes and has a permanent adhesive. It is excellent for application to regular surfaces, and durable both laminated and unlaminated, although lamination is recommended for protection against abrasion and chemical deterioration.

ESM-GCVP-75-30 ..30" x 75ft..... \$0.34/ft² \$63.99
ESM-GCVP-75-54 ..54" x 75ft..... 0.34/ft² 111.99

3mil Matte Calendered

This high-quality 3 mil matte adhesive-back uncoated vinyl is designed for many types of graphic applications. It images nicely in a variety of print modes and has a permanent adhesive. It is excellent for application to regular surfaces and durable both laminated and unlaminated, although lamination is recommended for protection against abrasion and chemical deterioration.

ESM-MCVP-75-30 ..30" x 75ft..... \$0.34/ft² \$63.99
ESM-MCVP-75-54 ..54" x 75ft..... 0.33/ft² 111.99

2mil Premium Cast

This premium-quality 2 mil glossy cast uncoated vinyl has a special permanent removable adhesive that is as durable but easier to apply and remove than traditional permanent adhesives. It is extremely durable and conformable to rivets and irregular curves or indentations, but lamination is highly recommended for fleet applications or to protect images from abrasion and chemical deterioration.

ESM-PCV2-80-30 ...30" x 80ft..... \$0.90/ft² \$179.99
ESM-PCV2-80-54 ...54" x 80ft..... 0.90/ft² 319.99

6mil Premium Reflective

This premium-quality 6 mil reflective cast uncoated vinyl has a permanent adhesive so it is durable for a variety of graphic applications including vehicle graphics. It is very durable and conformable to irregular curves or indentations, but lamination is

highly recommended for vehicle applications or to protect images from abrasion and chemical deterioration.

ESM-PRV2-50-30 ...30" x 50ft..... \$2.30/ft² \$287.99
ESM-PRV2-50-48 ...48" x 50ft..... 2.16/ft² 431.99

7mil View-Through

This updated version of our popular perforated 7 mil adhesive-back uncoated vinyl is designed for window graphics that require one-way view capability, including vehicle window graphics. While the product images well, care should be taken to avoid over-saturation as ink wells in the holes. This product is designed for flat or curved window surfaces with clean removal after 1 year (depending on environment and application). It is durable both laminated and unlaminated, although lamination is recommended for protection against abrasion and chemical deterioration and to keep dirt and debris from filling the holes.

ESM-VTV2-50-24 ...24" x 50ft..... \$2.36/ft² \$235.99
ESM-VTV2-50-53 ...53" x 50ft..... 2.28/ft² 503.99

3.5mil Water-Fast Matte

This water-resistant adhesive-back vinyl is a 3.5 mil calendered vinyl with a semi-permanent adhesive. This product exhibits very good image quality and the matte surface eliminates glare. Ideally suited for long-term indoor and medium-term outdoor applications, it will provide outdoor durability of 3-6 months without lamination. Not recommended for application over rivets, irregular curves or indentations.

PCM-WMWV-40-50 50" x 40ft..... \$1.02/ft² \$170.39

3.4mil Economy Calendered

This economy 3 mil glossy vinyl has a permanent acrylic adhesive and is designed for many types of inexpensive graphic applications. It images well, but it is not conformable to rivets and irregular curves or indentations. This product is not de-

signed for true long-term outdoor-durable graphics. Lamination is recommended for images that need protection against abrasion or chemical deterioration.

SCM-ECVP-75-30 ...30" x 75ft..... \$0.42/ft² \$79.99
SCM-ECVP-75-54 ...54" x 75ft..... 0.42/ft² 140.99

2mil Premium Cast

This premium-quality 2 mil glossy cast vinyl has a special permanent removable adhesive that is durable but easier to install and remove than traditional permanent adhesives. This vinyl is conformable to rivets and irregular curves or indentations, with **Avery Dennison Easy Apply Technology**.

SCM-PGVP-75-54 ..54" x 75ft..... \$1.30/ft² \$244.95

3mil Clear Adhesive Vinyl

This high-quality 3 mil vinyl has a fairly optically clear adhesive and is designed for many types of graphic applications, including stickers and decals, backlit graphics, counter and other display graphics. It images well in a variety of print modes and has a semi-permanent adhesive for applications that do not require a true permanent adhesive. It applies beautifully to smooth and regular surfaces and is durable both laminated and unlaminated; although lamination is recommended for protection against abrasion and chemical deterioration.

SCM-SPVCT-66-50 .50" x 66ft..... \$0.71/ft² \$196.47

4mil Opaque Heat Transfer Material

This garment transfer material is an opaque white media designed to be print and cut for heat transfer to light or dark garments, either cotton or cotton blend. Finished transfers offer terrific color with good handling. Suitable pigment, dye and mild solvent inks.

PCM-HTM2-50-24 .24" x 50ft..... \$1.50/ft² \$149.99
PCM-HTM2-50-50 .50" x 50ft..... 1.43/ft² 297.75

3mil HeatSoft™ Polyester Transfer Mask

Polyester hot transfer mask for heat transfer appliqué material, designed to lift graphic from its backing liner sheet without removing ink of the printed surface, and intended to release shortly after pressing. Acts as a protective barrier from the heat press.

PGM-PTM-50-24 ...24" x 50ft..... \$0.56/ft² \$56.00
PGM-PTM-50-50 ...50" x 50ft..... 0.54/ft² 112.00



Don't Forget the Laminates

Protect your Roland printed images from the elements... Check out our wide array of liquid and roll laminates.



Paper Roland

7.5mil Solvent Glossy Paper

This 7.5 mil glossy paper was specially coated for solvent ink printing. It has a good white point and gloss level for a wide variety of indoor graphic applications. A heat assist of 30-35°C (86-95°F) is helpful with this product, but care should be taken not to heat the paper too aggressively.

ESM-SGP2-100-30 ...30" x 100ft..\$0.26/ft²....\$63.99
ESM-SGP2-100-54 ...54" x 100ft...0.25/ft².....111.99

7mil Premium Matte Paper

This product is heavyweight and affordable, and an excellent choice for color graphics applications including posters, point of purchase displays, trade show and board room graphics. The high opacity and exceptional white point, along with this product's ability to handle heavy ink load, assure a quality reproduction. When lamination or encapsulation is part of the application, this premium matte product can reduce your cost with very little loss in image quality. This material prints well with pigment and mild solvent inks.

PCM-PMP3-100-30.....30" x 100ft...\$0.32/ft².....\$79.99
PCM-PMP3-100-42.....42" x 100ft....0.35/ft².....122.99
PCM-PMP3-100-50.....50" x 100ft....0.32/ft².....131.99
PCM-PMP3-100-60.....60" x 100ft....0.32/ft².....159.99

9mil Glossy Photobase Paper

This high-quality 9 mil glossy photobase paper was specially prepared for solvent ink printing. It has an excellent white point and gloss level for a wide variety of graphic applications. Designed for indoor use, prints can easily be mounted and laminated (finished) with pressure-sensitive products. When printing with a machine with heating elements, a heat assist of 30-35°C (86-95°F) is helpful, but care should be taken not to heat the paper too aggressively.

SCM-GPPG-131-50..50" x 131ft..\$0.67/ft²..\$367.99

Film Roland

3mil Clear Solvent Film

This high-quality 3 mil clear polyester film has a special topcoat for mild solvent ink printing. It images well for a variety of applications including overlays and other clear film graphics. It is designed for excellent indoor durability although care should be taken when handling the material.

ESM-CSF-66-4848" x 66ft...\$0.73/ft²....\$191.99

6mil Premium Backlit Film

This unique film is specially formulated for mild solvent ink printing. It is a medium weight 6 mil film designed to be front print and displayed either front lit or backlit for a variety of display and trade show graphic applications. This material has an excellent indoor longevity but should be mounted and laminated with high-quality pressure-sensitive adhesives.

ESM-PBF-98-3030" x 98ft...\$0.75/ft²....\$183.99
ESM-PBF-98-5454" x 98ft....0.75/ft².....327.99

5mil Water-Fast Backlit Film

This backlit film offers vibrant color at an affordable cost-per-square-foot for dye or pigment ink printing. It performs very well in conventional backlit applications and its water-resistant [water-fast] properties allow it to be used for some outdoor applications without concern for print deterioration from condensation. This product is designed to be reverse-imaged on the second surface and therefore, requires no lamination for standard backlit applications. It can also be mounted and laminated with high-quality pressure-sensitive adhesives.

PCM-WBF2-100-5050" x 100ft..\$0.67/ft²...\$279.99

5mil Hi-Gloss White Film

If the Hi-Fi JET has a signature media, this is it. Brilliant white film with exceptional dot definition for highest resolution printing makes this a must for photography and high profile presentations. Additionally, the product is water-resistant [water-fast] and exhibits quick dry properties although care should be taken when handling the product. This material was developed for use with aqueous inks.

PQM-PETG-66-41 .41" x 66ft...\$1.42/ft²....\$319.99
PQM-PETG-66-52 .52" x 66ft....1.40/ft².....\$399.99



Check out our selection of Roland equipment

NEW from Roland VersaUV

Don't See It Here?
Call and Ask!

Fine Art Roland

18mil

Matte Artist Canvas

This medium weight matte topcoat cotton/polyester blend canvas offers an excellent white point and images well in a variety of print modes. It is designed to be dry to the touch immediately after printing, and offers exceptional water-resistant properties and excellent longevity and durability. Auto sheet cutting is not recommended with this media.

PCM-MAC7-40-24 24" x 40ft \$1.50/ft² \$119.99

PCM-MAC7-40-42 42" x 40ft 1.51/ft² 211.99

PCM-MAC7-40-52 52" x 40ft 1.50/ft² 259.99

PCM-MAC7-40-60 60" x 40ft 1.50/ft² 299.99

23mil

Tuscan Rag Bright White

This 310 gsm paper is a wonderful bright white with exceptional smoothness for excellent color and black & white photographic output. It is 100% cotton fiber and mould-made and is PH neutral, acid free and lignen-free. This heavier weight paper is specifically engineered for wide-format inkjet printing and is water-resistant [water-fast] when used with our pigment ink set. When printing on the Hi Fi JET or CAMMJET, use the highest head position to produce best quality results.

PQM-TRBW-40-47 47" x 40ft \$1.26/ft² \$198.39

28mil

Solvent Satin Canvas

Brightwhite, top-coated material designed specifically for Eco Sol Max[®] inks. Low-glare finish, superior color brilliance. Moisture resistant, poly/cotton blend can be stretched without cracking. Ideal for long term display.

ESM-SSC-75-30 ... 30" x 75ft \$1.00/ft² \$187.99

ESM-SSC-75-54 ... 54" x 75ft \$1.01/ft² 339.99

Solvent Gloss Canvas

Same as the ESM Solvent Satin Canvas above, but offers a high-sheen finish. As with the satin, gloss canvas is ideal for art décor, fine art reproduction, photography backdrops, and murals.

ESM-SGC-75-30 ... 30" x 75ft \$1.00/ft² \$187.99

ESM-SGC-75-54 ... 54" x 75ft \$1.01/ft² 339.99

Specialty Roland

14mil

Premium Solvent Glossy Banner

This premium-quality 14 mil glossy scrim banner vinyl was specially prepared for our solvent inks. It can be hemmed and grommited and offers a waterproof solution for outdoor applications (depending on weather and environmental conditions and the specifics of mounting). Large banners displayed outdoors should be tested for wind resistance depending on the required durability and longevity of the application.

SCM-SPVCB-66-50 .. 50" x 66ft \$1.07/ft² \$294.39

Companion Laminates
Pages 15-17



Overlaminates Film Roland

3mil

Calendered Luster Film

This high-quality 3 mil calendered vinyl overlaminates film is perfect for both indoor and some outdoor applications requiring less flexibility and durability than cast vinyl film. It offers a unique semi-gloss or luster look for glare-reduction. Performance is guaranteed for up to 25 months outdoors depending on the substrate and ink type used, either Roland pigment or mild solvent inks. This is a pressure-sensitive film that is also suitable for laminating other Roland media for added protection and durability.

PGM-OLCL-150-54 54"x150ft \$0.38/ft² \$255.99

2mil

Premium Cast Glossy Film

This premium-quality 2 mil vinyl overlaminates film is the perfect solution for all types of indoor and outdoor applications. It offers generous flexibility with a high gloss finish for maximum impact. Performance is guaranteed for up to 60 months outdoors depending on the ink type used, either Roland pigment or mild solvent inks. This is a pressure-sensitive film that is very durable and flexible, and is therefore suitable for laminating all other Roland media for added protection and durability.

PGM-OLPG2-150-30 .. 30"x150ft \$0.71/ft² \$267.99

PGM-OLPG2-150-54 .. 54"x150ft 0.71/ft² 479.99

Banner Material



LG Hausys

10oz Bannux 5500

Value choice for solvent inkjet printing. Can be used with pressure sensitive vinyl.

5500-3933 39" x 33y 23¢/ft ² \$75.00
5500-5433 54" x 33y 23¢/ft ² 105.00
5500-6333 63" x 33y 23¢/ft ² 120.25

12/14oz Bannux USB

Printable on BOTH sides. Indoor only.

USB12-3933 12oz... 39" x 33y 34¢/ft ² \$110.00
USB12-5433 12oz... 54" x 33y 34¢/ft ² 150.99
USB14-3933 14oz... 39" x 33y 40¢/ft ² 127.30
USB14-5433 14oz... 54" x 33y 40¢/ft ² 176.24

130z Bannux UGS Gloss



Perfect solution for outdoor billboarding. Solvent inkjet printing, designed for front-lit billboards.

UGS13-3033 30" x 33y 25¢/ft ² \$62.99
UGS13-3933 39" x 33y 25¢/ft ² 78.00
UGS13-5433 54" x 33y 25¢/ft ² 108.00
UGS13-6333 63" x 33y 25¢/ft ² 125.99
UGS13-7333 73" x 33y 25¢/ft ² 146.00

130z Bannux UMS Matte

For outdoor billboarding with a matte finish. Solvent inkjet printing, designed for front-lit billboards.

UMS13-3033 30" x 33y 25¢/ft ² \$62.99
UMS13-3933 39" x 33y 25¢/ft ² 78.00
UMS13-5433 54" x 33y 25¢/ft ² 108.00
UMS13-6333 63" x 33y 25¢/ft ² 125.99
UMS13-7333 73" x 33y 25¢/ft ² 146.00

PROFILES AVAILABLE ON OUR WEBSITE!

14oz VIZUON XIGN™ Blockout



A curling-resistant, Blockout banner material that provides optimal results for both digital and screen printing. It breaks free from the traditional manufacturing method by incorporating PET into the product, leaving out the need for fabric.

Compatible with LG Hausys VizuonCal 4000 & 6000 Vinyls



- UV curable media
- Matte & smooth on both sides
- Ideal for digital & screen printing
- Non-wrinkling, non-fabric
- Curling-resistant
- Great block-out properties



XIGN-3933 39" x 33y 61¢/ft ² \$195.00
XIGN-5433 54" x 33y 61¢/ft ² 270.00

VIZUONBANNUX™

Flexible Sign Faces

Section Guide		5500	USB12	UGS	UMS	1100	USB14	110B
Weight	7oz-10oz	○						
	11oz-13oz		○	○	○	○		
	14oz-16oz						○	○
Treatment	Anti mildew	○	○	○	○	○	○	○
	Ultraviolet	○	○	○	○	○	○	○
	Fire resistance	○	○	○	○	○	○	○
Ink	Solvent based	○	○	○	○	○	○	○
	Gloss			○				
Finish	Matte	○	○				○	○
	Front lit signboard	○	○				○	○
Application	Indoor signs	○	○				○	○
	Outdoor signs	○		○	○	○		○
	Small size signage	○		○	○	○		○
	Billboard			○	○			
Feature	Movie poster		○				○	○
	Black-out effect		○				○	○
	Both side printable		○				○	○
	Good for screen print		○				○	○

160z Bannux 110B Blockout

Better choice for solvent inkjet and outdoor screen printing.

BAN-110B-3933	39" x 33y 41¢/ft ² \$131.50
BAN-110B-5433	54" x 33y 41¢/ft ² 182.05

Let the Pros at Aksarben finish your digital banners as well!



With over 20 years experience, our staff can provide a fast turnaround time while taking the best care of your digital banners.

No quantity too LARGE or too small.

- Lamination
- Equipment
- Ink & Parts
- Services
- Custom Banners
- Vinyl
- Apparel Transfer
- Sign Supplies
- Tapes
- Displays
- Software & Fills
- LEDs
- Electrical
- Substrates

Pressure Sensitive Calendered Vinyl

VIZUONPRINT™ "Lay Flat" Surface for Decals and Vinyl Lettering.

3.2mil Vizuon LS2740

2-year opaque film for high rez screen & digital printing.

- LS2740G-5450 Gloss 54" x 50y..... 19¢ ft² ..\$125.85
- LS2740G-6050 Gloss 60" x 50y..... 19¢ ft² 139.85
- LS2740M-5450 Matte 54" x 50y..... 19¢ ft² 125.85
- LS2740M-6050 Matte 60" x 50y..... 19¢ ft² 139.85

4mil Vizuon LD3810

3-year outdoor vinyl. White, opaque for solvent inkjets.

- LD3810G-3050 Gloss 30" x 50y..... 23¢ ft² \$88.10
- LD3810G-5450 Gloss 54" x 50y..... 22¢ ft² 150.95
- LD3810G-6050 Gloss 60" x 50y..... 22¢ ft² 167.75
- LD3810M-3050 Matte 30" x 50y..... 23¢ ft² 88.10
- LD3810M-5450 Matte 54" x 50y..... 22¢ ft² 150.95
- LD3810M-6050 Matte 60" x 50y..... 22¢ ft² 167.75

3.2mil Vizuon LD383

AIRFREE™

NEW repositionable adhesive! 3-year outdoor vinyl.

White, opaque PVC film for solvent inkjet printing.

- LD383TG-3050 Gloss 30" x 50y..... 33¢ ft² ..\$124.05
- LD383TG-5450 Gloss 54" x 50y..... 32¢ ft² 212.65
- LD383TG-6050 Gloss 60" x 50y..... 32¢ ft² 236.25
- LD383TM-3050 Matte 30" x 50y..... 33¢ ft² 124.05
- LD383TM-5450 Matte 54" x 50y..... 32¢ ft² 212.65
- LD383TM-6050 Matte 60" x 50y..... 32¢ ft² 236.25

3.2mil Vizuon LD3880G

1-year ultra high tack pressure-sensitive adhesive designed for high-rez solvent inkjet printing.

- LD3880G-5450 Gloss 54" x 50y..... 50¢ ft² ..\$337.50

3.2mil Vizuon LD3910

5-year outdoor. Opaque calendered film. Gloss & Matte

- LD3910G-5450 Gloss 54" x 50y..... 32¢ ft² ..\$212.65
- LD3910G-6050 Gloss 60" x 50y..... 32¢ ft² 236.25
- LD3910M-5450 Matte 54" x 50y..... 32¢ ft² 212.65
- LD3910M-6050 Matte 60" x 50y..... 32¢ ft² 236.25

3.2mil Vizuon LD393

AIRFREE™

NEW repositionable adhesive! 5-year outdoor vinyl.

White, opaque calendered film for solvent inkjet printing.

- LD393TG-3050 Gloss 30" x 50y..... 42¢ ft² ..\$155.90
- LD393TG-5450 Gloss 54" x 50y..... 40¢ ft² 266.80
- LD393TG-6050 Gloss 60" x 50y..... 40¢ ft² 296.45
- LD393TM-3050 Matte 30" x 50y..... 42¢ ft² 155.90
- LD393TM-5450 Matte 54" x 50y..... 40¢ ft² 266.80
- LD393TM-6050 Matte 60" x 50y..... 40¢ ft² 296.45

Pressure Sensitive Graphic Film

Section Guide		LD 3810G	LD 3810M	LD 3910G	LD 4910M	LM 50000	LM 53000
Feature	Air Free	●	●				
	Perforated					●	●
Finish	Gloss	●		●			
	Matte		●		●	●	●
Type	Calendered	●	●	●	●	●	●
	Monomeric	●					
	Polymeric			●	●		
Duration	Short-term (~1 year)	●	●			●	●
	Long-term (2-5 years)		●	●	●		
Uses	Indoor Signage	●	●	●	●	●	●
	Outdoor Signage	●	●	●	●	●	●
	Point-of-purchasing	●	●	●	●	●	●
	Trade Show Displays	●	●	●	●	●	●
	Vehicle & Fleet Marking	●	●	●	●	●	●
Window Graphics					●	●	
					●	●	
Ink	Solvent-based Ink	●	●	●	●	●	●
	Clear	●	●	●	●	●	●
Adhesive	Grey					●	●
	Solvent-based Acrylic	●	●	●	●	●	●
	Permanent	●	●	●	●	●	●
	Removable	●	●	●	●		

● Option

AIRFREE™ Technology

Easily Remove Air Bubbles

AIRFREE™ technology makes it easier to remove trapped bubbles and enhancing adhesion.

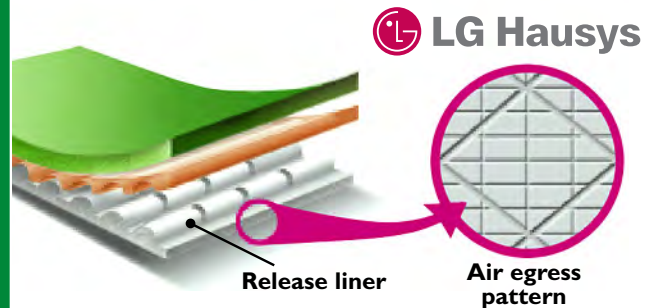

- Air Egress Technology
- Wrinkle-free application
- Clean removal
- Easy repositioning
- 98# release liner
- 8 year durability
- Grey solvent-based Adhesive

4mil Vizuon LD4910

5-year outdoor Matte. Easy-to-use, Precise Results. Translucent Backlit Film.

- LD4910M-5450 Matte 54" x 50y..... 36¢ ft² ..\$240.25
- LD4910M-6050 Matte 60" x 50y..... 36¢ ft² 266.95

Premium Cast Vinyl



LG Hausys

2.3mil VIZUONCAST™ LD823

Long-term outdoor durability for up to **7 years**

- NEW **Repositionable adhesive**
- Excellent printing performance
- Excellent weather resistance
- AiRFREE™ technology allows trapped air to be released during application, increasing overall productivity
- Outstanding dimensional stability
- Lays flat, even in humid conditions
- Solvent inkjet printing
- Outdoor displays, signs, and vehicle wrap

AIRFREE™

LD823TG-3050 AIRFREE 30" x 50y.... 91¢ ft²..... \$341.10
LD823TG-5450 AIRFREE 54" x 50y.... 87¢ ft²..... 584.75

Sealing Pen

The SEALIT PEN is a quick and easy way to seal the edges of your graphics. Fast drying acrylic clear with UV blockers recommended for all vehicle graphics. Use mineral spirits to remove any excess.

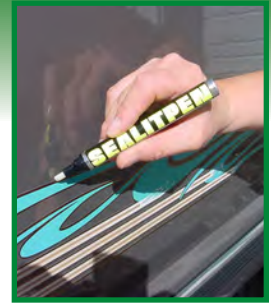

SEALIT PEN \$9.99ea

Window Film VIZUONPRINT™

Use companion Laminate LP89000 – page 16

Perforated See-through Calendered PVC Film

Excellent printing performance in solvent inkjet printers. Remove adhesive, printable graphic film with see-through capability.



Great for vehicle graphics, and display or corporate ID applications



50% View Thru LM50000

Suitable for car windows

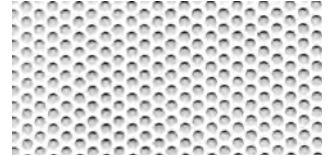

LM50000-4830 48" x 30y..... \$1.60 ft² \$575.00
LM50000-5430 54" x 30y..... 1.60 ft² 645.00

30% View Thru LM53000

Suitable for store front windows

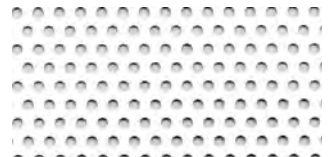

LM53000-4830 48" x 30y..... \$1.60 ft² \$575.00

MetaMark® Calendered Vinyl

MD5 Digital Vinyl

MetaMark MD5 is a premium quality polymeric calendered vinyl, which has been specially engineered to give outstanding performance with solvent inkjet printers. The MetaMark MD5 allows the consistent production of exceptional print quality on a material with an exterior life of 7 years, and which is suitable for application to most surfaces.

MD5-WHT-GL-30, Gloss... 30" x 164 ft... 45¢ ft² ... \$183.00
MD5-WHT-GL-54, Gloss... 54" x 164 ft... 45¢ ft² 329.00
MD5-WHT-M-54, Matte.... 54" x 164 ft... 45¢ ft² 329.00
MD5-CL-54, Clear 54" x 164 ft... 45¢ ft² 329.00

METAMARK

MD3 Digital Vinyl

Giving excellent and consistent print results on most solvent inkjet printers, the MD3 is a monomeric calendered vinyl which offers an economical alternative for shorter term print applications without sacrificing print quality.

MD3-WHT-GL-54, Gloss... 54" x 164 ft... 33¢ ft² ... \$246.00
MD3-WHT-M-54, Matte.... 54" x 164 ft... 33¢ ft² 246.00



Intellicoat®

INFO: magicinkjet.com/product-list.htm

- Lamination
- Equipment
- Ink & Parts
- Services
- Custom Banners
- Vinyl
- Apparel Transfer
- Sign Supplies
- Tapes
- Displays
- Software & Fills
- LEDs
- Electrical
- Substrates

Digital Media

Artist Canvas

Ink jet artist canvas for solvent ink printers

- Acid-free, matte or glossy finish
- Stretch canvas designed for long-term reproductions when imaged with solvent and eco-solvent ink jet printers
- Water resistance when printed with solvent inks

Matte

GFCVM-3040	63¢/ft ²	30" x 40'	\$62.75
GFCVM-3615	61¢/ft ²	36" x 15'	28.24
GFCVM-3675	63¢/ft ²	36" x 75'	141.21
GFCVM-5475	63¢/ft ²	54" x 75'	211.82

Glossy

GFCVG-3620	1.23/ft ²	36" x 20'	\$74.06
GFCVG-3675	1.23/ft ²	36" x 75'	277.70
GFCVG-5475	1.23/ft ²	54" x 75'	416.55

Photo Paper

Photo realistic paper for solvent ink jets

- Photo realistic paper
- Designed for solvent and eco-solvent ink jet printers
- Cost effective solution for printing short-term graphics
- Extremely smooth surface for high photographic resolution

GFPHOTO-30100	29¢/ft ²	30" x 100'	\$73.70
GFPHOTO-3620	29¢/ft ²	36" x 20'	17.25
GFPHOTO-36100	29¢/ft ²	36" x 100'	88.44
GFPHOTO-54100	29¢/ft ²	54" x 100'	127.34

Pressure Sensitive Adhesive

GFPHOPSA-3620	71¢/ft ²	36" X 20'	42.76
GFPHOPSA-50100	71¢/ft ²	50" X 100'	296.92

Polypropylene

Glossy Polypropylene Banner For Solvent Ink Jets

- For indoor and roll up applications
- Designed for solvent and eco-solvent ink jet printers
- Cost effective solution for printing short-term banners, P.O.P. displays, roll up displays, and posters

GFPPOLY-30100	34¢/ft ²	30" x 100'	\$85.86
GFPPOLY-3620	34¢/ft ²	36" x 20'	20.61
GFPPOLY-36100	34¢/ft ²	36" x 100'	103.02
GFPPOLY-54100	34¢/ft ²	54" x 100'	154.55

▲ Discontinued Product

Latex Paper

Indoor/outdoor poster paper for solvent ink printing systems

- One-sided coated paper
- Distinctive luster finish
- Strength, flexibility and durability, resists cracking when folded
- Film lamination is not required in most intended applications

Pressure Sensitive 6mil ▲

GFIOP140PSA-3615	43¢/ft ²	36" x 15'	\$19.18
GFIOP140PSA-3690	43¢/ft ²	36" x 90'	115.03

Standard 6mil

GFIOP140-5420	21¢/ft ²	54" x 20'	\$19.11
GFIOP140-54150	21¢/ft ²	54" x 150'	143.22

Standard 9.9mil

GFIOP212-5420	26¢/ft ²	54" x 20'	\$23.00
GFIOP212-54150	26¢/ft ²	54" x 150'	172.57

Tyvek®

Tyvek indoor/outdoor banner for solvent ink jet printing

- Banner grade, tear resistant 9 mil Tyvek
- Longer-term indoor and outdoor promotional materials

TB9-3650	1.76¢/ft ²	36" x 50'	\$264.70
TB9-5475	1.76¢/ft ²	54" x 75'	595.63

Tear Resistant Paper

Tear-Resistant, wet strength poster 9.7 mil paper

- Tear-resistant, one-sided coated
- For solvent and eco-solvent ink jet
- Latex-saturated, nylon-reinforced
- For short term, indoor promotional applications

GFTRP-54150	30¢/ft ²	54" x 150'	\$203.96
--------------------------	---------------------------	------------------	----------

PosterMax

- A luster finish 8.5 mil for high production Solvent and ECO-Solvent ink jet printers
- Latex-saturated, wet strength paper
- Resists cracking when folded
- Indoor/Outdoor

POSTERMAX-5420	30¢/ft ²	54" x 20'	\$27.00
POSTERMAX-54200	30¢/ft ²	54" x 200'	270.00

Clear

Polyester Film

Glossy clear film

- Excellent image quality
- Indoor/Outdoor

SCF7-3610	80¢/ft ²	36" x 10'	\$24.00
SCF7-36200	80¢/ft ²	36" x 200'	480.00
SCF7-54200	80¢/ft ²	54" x 200'	720.00
SCF7-60100	80¢/ft ²	60" x 100'	400.00

Mural-Pro

Aqueous & solvent systems

- Latex-based ink jet wallcovering media
- Economical alternative to adhesive vinyl for in-store graphics
- Similar print and posting performance as DMiBOP without the added costs of nylon reinforcement.

MURALPRO-3610	85¢/ft ²	36" x 10'	\$25.59
MURALPRO-3675	85¢/ft ²	36" x 75'	191.81
MURALPRO-5475	85¢/ft ²	54" x 75'	287.69

POS Pro+200

Block-out polyester film

- BRIGHT WHITE printing surface for added color pop.
- 10.4 mil, anti-curl
- High image quality along with durability
- Matte coating compatible with both aqueous pigment and solvent ink jet printers

POSPRO200-3610	1.14/ft ²	36" x 10'	\$34.14
POSPRO200-36100	1.14/ft ²	36" x 100'	341.30
POSPRO200-50100	1.14/ft ²	50" x 100'	473.26

POS Pro+300

Block-out polyester film

- Improved BRIGHT WHITE printing surface for added color pop
- 14.5 mil, opaque matte, printable polyester backer
- High image quality, durable
- Compatible with both aqueous pigment and solvent ink jet printers

POSPRO300-3610	\$1.77/ft ²	36" x 10'	\$53.09
POSPRO300-36100	1.66/ft ²	36" x 100'	496.78
POSPRO300-50100	1.66/ft ²	50" x 100'	692.06

InteliCoat®



Tell customers your product can be recycled!!!

Print the proper symbol on your InteliCoat media.
Recycle symbols available in vector format on our website.



Lamination

Equipment

Ink & Parts

Services

Custom Banners

Vinyl

Apparel Transfer

Sign Supplies

Tapes

Displays

Software & Fills

LEDs

Electrical

Substrates

Digital Media

Total Photo Matte

Universal photorealistic paper

- For use on both aqueous pigment & dye as well as solvent & eco-solvent printers
- Ultra-smooth matte surface combined with high ink saturation provide rich, dense colors

TOTALPHOTOM-3610	37¢/ft ²36"x10'.....	\$11.21
TOTALPHOTOM-36100	37¢/ft ²36"x100'.....	112.16
TOTALPHOTOM-50100	37¢/ft ²50"x100'.....	155.52

Indoor Matte

Low cost poly banner

- Polypropylene banner for indoor use.
- Matte surface is ideal for minimizing glare that occurs with indoor lighting

PPM7-3610	61¢/ft ²36"x10'.....	\$18.18
PPM7-36100	61¢/ft ²36"x100'.....	181.73
PPM7-54100	61¢/ft ²54"x100'.....	252.00

Fabric Banner

6.8mil, 100% polyester woven fabric for solvents

- Ideal for producing flags, displays, window decorations, pop-up displays, and window backlit.
- Has a unique ink jet coating that allows it to be compatible on most solvent ink jet piezo printers.

FAB6-3610	1.09/ft ²36"x10'.....	\$32.81
FAB6-36150	1.09/ft ²36"x150'.....	485.88
FAB6-50150	1.09/ft ²50"x150'.....	673.92

Flame Resistant Fabric

7mil Fabric Thickness
100% polyester woven fabric

- Luster Finish
- Flame retardant: passes NFPA701 standard
- For solvent & eco-solvent printers

FABFR-3610	1.14/ft ²36"x10'.....	\$34.34
FABFR-36150	1.14/ft ²36"x150'.....	515.16
FABFR-50150	1.14/ft ²50"x150'.....	715.50

Backlit Film

Polyester Film solvent ink jet backlit film

- 7 mil polyester backlit film for use is solvent and eco-solvent inkjet piezo printing systems.
- Recommended as a front print and light box applications
- Provides maximum transmitted and reflected ink density ensuring vivid color and high image resolution
- Suitable for both indoor and outdoor light box graphics

SBL7-3620	73¢/ft ²36"x20'.....	\$43.49
SBL7-36100	73¢/ft ²36"x100'.....	217.49
SBL7-54100	73¢/ft ²54"x100'.....	326.47

WATERBASE SELECTIONS

Photo Paper

Photobase paper for dye & pigment ink
10mil, Resin-coated photobase paper
Luster Surface, Premium Feel, 50 year+ light stability with pigmented inks

SIENA250L-36100	44¢/ft ²36"x100'.....	\$146.29
SIENA250L-50100	46¢/ft ²50"x100'.....	214.74
SIENA250L-54100	44¢/ft ²54"x100'.....	216.72

Matte Vinyl

For Dye & Pigment Ink
5mil Calendered Vinyl w/Adhesive Back
Indoor or Outdoor Posters, Board Mounted Signs, POP Signage

DMVLA5-3640	\$1.25/ft ²36" X 40'.....	\$149.90
DMVLA5-3675	1.25/ft ²36" X 75'.....	278.29
DMVLA5-5440	1.25/ft ²54" X 40'.....	223.63

FabTac

8mil fabric banner w/low tack adhesive

- Pressure-sensitive adhesive for aqueous inkjet or pigment ink systems.
- Ideal for displays, window decorations, window backlits & wall murals.
- Repositionable

FABTAC-3610	\$1.91/ft ²36" X 10'.....	\$57.20
FABTAC-36100	1.25/ft ²36" X 100'.....	374.49
FABTAC-50100	1.25/ft ²50" X 100'.....	516.76

17mil Matte Canvas

Torino cotton/poly blend canvas for dye & pigment ink

- Acid Free Matte Canvas
- 100+ Year Image Stability

TORINO17M-3640	\$2.13/ft ²36" X 40'.....	\$255.72
TORINO17M-5040	2.13/ft ²50" X 40'.....	\$356.15



REDUCE REUSE RECYCLE



1 Terephthalate (PET)
Found in carpet fiber, fleece, comforter fill, food containers, film, strapping,...



2 High Density Polyethylene (HDPE)
non-food bottles, plastic lumber, floor tiles, picnic tables,...



4 Low Density Polyethylene (LDPE)
liners, shipping envelopes, trash cans, floor tiles, furniture,...



5 Polypropylene (PP)
Automotive applications, brooms, ice scrapers, rakes, storage bins,...



Paper
Check w/local recycle outlet. Used in books, posters, catalogs, shopping bags,...

Special Media



A Bemis Company



Street Rap Concrete floor graphics - 3mil Matte White

- Designed for the production of outdoor sidewalk and parking lot floor graphics
- Aggressive specially engineered adhesive bonds well to smooth concrete and asphalt surfaces
- Can be printed with solvent, eco solvent and UV cured inkjet inks and UV or solvent screen inks
- Must be laminated

SUGGESTED OVERLAMINATE FOR STREET RAP

Mactac IP6200 and PF6300
STR328W5450 54"x50' 90¢/ft² \$202.50

Wall Noodle

Reusable 6mil matte white

- Easily applied and removed
- 6.0 mil Matte White face stock for superior printability
- Semi-rigid Calendered PVC film
- For UV Screen and Solvent Based Printing

Typical uses: Short term 6 month to 1 year indoor wall graphics designed for smooth flat surfaces

WN628W54..... 54"x100' 44¢/ft² \$199.99

Bubble Free

2.1mil Gloss white

High performance Cast PVC Film

- Designed for solvent based inkjet printing
- Long term outdoor vehicle; flat, curved & riveted surfaces
- 10 year outdoor durability
- Highly conformable and repositionable

SUGGESTED OVERLAMINATE FOR BUBBLE FREE

LF3640 PermaColor RAYZor Permacolor Enhancers

by Mactac

JT5529BFD 54"x164' 73¢/ft² \$539.99

Digital Media for Textile Transfers

See page 41 under the Apparel Transfer section

Printable Magnetic Media



Lead-free Flexible Magnetic Vinyl

Magnetic printable material

- Vehicle signs
- Promotional products, Business cards
- Indoor durability up to 3 years
- Outdoor durability up to 1 year
- For use with Eco-Solvent and UV based printers



12 mil

SPMMAG012-2410N 24" x 10' \$1.79 ft² \$35.80
SPMMAG012-2425N 24" x 25' 1.03 ft² 51.50
SPMMAG012-2450N 24" x 50' 85¢ ft² 89.00

20 mil

SPMMAG020-2410 24" x 10' \$1.96 ft² \$39.20
SPMMAG020-2425 24" x 25' 1.25 ft² 62.57
SPMMAG020-2450 24" x 50' 1.10 ft² 110.00

30 mil*

SPMMAG030-2410N 24" x 10' \$2.46 ft² \$49.20
SPMMAG030-2425N 24" x 25' 1.82 ft² 91.00
SPMMAG030-2450N 24" x 50' 1.17 ft² 117.00

*(Check with your printer specifications prior to use...it be thick!)

IMPORTANT Magnetic Prep & Care Instructions

It is very important to make sure the vehicle surface is clean and moisture free before applying any magnetic. For newly painted vehicles allow 90 days before applying magnetic. Allow at least 48 hours of cure time for waxed surfaces. When applying make sure the magnetic is flat against the entire surface. (No air pockets). Avoid horizontal metal surfaces exposed to direct sunlight; temperatures exceeding 160 degrees. It is recommended that you that you remove and clean both the magnetic sign and the vehicle surface on a daily bases. Failure to do so could result in permanent damage.

Special Media

3M INK JET MEDIA



IJ160C-10

3M Controltac Graphic Film with Comply Adhesive

- 4mil Opaque White
- 3 Year Outdoor Durable
- Repositionable & Removable Grey Adhesive

3MIJ160C-5450 54" X 50yd..... \$0.72/ft² \$488.50

IJ180C-10

3M Controltac Graphic Film with Comply Adhesive

- 2mil Cast Semi-Gloss White
- 5 Year Outdoor Durability
- Repositionable & Removable Grey Adhesive

3MIJ180C-5450 54" X 50yd..... \$0.98/ft² \$660.89

IJ180CV3-10 NEW

3M Controltac Graphic Film with Comply Adhesive

- 2mil Cast Gloss White
- Non-visible air release channels (offers the ultimate in air release technology)
- 5 Year Outdoor Durability
- Repositionable & Removable Grey Adhesive

3MIJ180CV3-5050 54" X 50yd..... \$1.15/ft² \$778.75

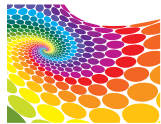

PureColor™ Media

Neschen PureColor™ is designed for use with most solvent & eco-solvent printers

Versa Fabric

7.7oz. Coated 100% Polyester

- Indoor/Outdoor
- Wrinkle resistant
- Roll-up, pop-up, soft image, store signage, murals, trade show, POP, tent sides

6318012..... 41"x50' 81¢/ft² \$139.00

6318013..... 54"x164' 80¢/ft² \$589.00

Calypso Breeze Satin

3.5oz. Translucent Satin Polyester

- Special coating delivers photo realistic imaging with wide color gamut
- Fast dry time, excellent scratch resistance
- Ideal for backlit and roll-up displays, window graphics and short term outdoor signage

• Also UV printable

6318052..... 54"x100'68¢/ft² \$306.00

Monet Canvas

Heavyweight 10oz. Coated Canvas

- Ideal for giclee art reproductions, eye catching POP, trade show and store signage
- Uniform matte texture and specialized coating allows for vibrant, photorealistic printing with a wide color gamut.

• Tight weave allows it to be used with vacuum-carried flat bed UV printers

6318022..... 54"x82' 69¢/ft² \$257.00



CONVEX SPORT VINYL



With compatible Convex or Pro-Shield laminates, you can make thick, durable decals that can take a real beating. Convex brand vinyl is very flexible and conforms to most curved surfaces.

Convex High-Bond

For durable interior and exterior markings

- 6mil Matte White, 2mil adhesive
- Decals for motocross bikes, ATVs, vehicles, gasoline pumps, vending machines, ATMs, outdoor power equipment,...
- High-Bond adheres well to powder coat paint.
- 7 year outdoor durability

CVXHB-2010 20" x 10yd \$1.28/ft² \$63.75

CVXHB-2050 20" x 50yd 1.05/ft² 263.00

CVXHB-3010 30" x 10yd 1.32/ft² 99.00

CVXHB-3050 30" x 50yd 1.05/ft² 395.00

DICKSON DIGITAL BANNER MEDIA



JET 520 Frontlit

Great choice for printing banners, signage, POS, and other indoor outdoor communication

- 16 oz Banner Material
- Suitable printing for Solvent, Eco- Solvent, and UV inks.

DNJET520-30 30" x 98' \$1.16/ft² \$283.00

DNJET520-54 54" x 98' 0.96/ft² 424.00

GMI® Digital Media

Graphic Materials International (GMI) offers an extensive line of digital imaging media. Their media runs the gamut from conventional vinyls and overlaminates, to more specialized digital media for applications such as banners, Walk-On Graphics, Wall Graphics, window graphics, vehicle graphics, and P.O.P. displays.

7mil Photo Gloss Paper

Premium resin-coated photobase paper with a high gloss finish.

PART#	SIZE	sq/ft	PRICE	ROLL PRICE
SPMSPBP30100N	30" X 100'	38¢		\$95.75
SPMSPBP54100N	54" X 100'	38¢		176.10

7.5mil Semi-Matte Backlit Film

This front print semi-matte backlit film offers maximum color density with vivid and high output resolution for any image. Applications include light boxes, bus stops, vending machines, window & glass displays, trade shows P.O.P. displays and posters.

SPMSBL3050N	30" X 50 yd	73¢		\$273.75
SPMSBL5425N	54" X 25 yd	73¢		246.40
SPMSBL5450N	54" X 50 yd	73¢		492.75

Window Graphics Vinyl

ECONOMY GRADE PERFORATED ONE-WAY VISION FILM

For EXTERIOR use in black/white with 1.65 mm diameter. Ideal for glass window graphics requiring graphics on one side and a clear, unobstructed view through the other. Durable up to 2 years.

SPMEPWE5450N	54" X 50'	\$1.00		\$225.00
--------------	-----------	--------	--	----------

8.0mil Hi-Stat Static Cling Vinyl

A clear or white, interior, flexible static cling vinyl which adheres to most, clean, highly polished smooth surfaces without adhesive. Ideal for window displays, point of purchase decals, seasonal decals, oil change labels, price stickers and vehicle advertising. Durable up to 2 years - Window Glass.

SPMHSC3050N	30" X 50 yd	31¢		\$116.25
SPMHSC5450N	54" X 50 yd	31¢		209.25
SPMHSW3050N-WHT	30" X 50 yd	31¢		116.25
SPMHSW5450N-WHT	54" X 50 yd	31¢		209.25

4.0mil Sign-Ad White Calendered Vinyl

A matte white, flexible vinyl with a specially formulated low-tack adhesive used for interior and exterior applications with no solvents required.

SPMSSA3050N	30" X 50 yd	30¢		\$112.50
SPMSSA5450N	54" X 50 yd	30¢		205.25

4.0mil Clear-Ad Clear Calendered Vinyl

A clear, flexible vinyl with a specially formulated, low-tack removable adhesive for easy application and removability which leaves no residue.

PART#	SIZE	sq/ft	PRICE	ROLL PRICE
SPMSCAD3050N	30" X 50 yd	32¢		\$120.00
SPMSCAD5450N	54" X 50 yd	32¢		216.00

Gloss White Semi-Rigid Vinyl

A semi-rigid PVC, printable on both sides. Excellent for signs, P.O.P. displays, permits and identification tags, door hangers, table top menus. Outdoor durable.

SPMRGV105250N	52" X 50 yd	83¢		\$539.50
---------------	-------------	-----	--	----------

Wall Graphic Vinyl

Wall Graphics are used for highly effective advertisements and promotions. With an ultra removable and reusable adhesive, they are intended for use as a high quality interior marking in decal applications requiring easy removal from walls with smooth surfaces. Wall Graphics are recommended for smooth, dry, cleaned and flat surfaces.

8.0 MIL

SPMWG83050N	30" X 50 yd	44¢		\$165.00
SPMWG85450N	54" X 50 yd	44¢		297.00

6.0MIL

SPMWG63050N	30" X 50 yd	38¢		\$142.50
SPMWG65450N	54 X 50 yd	38¢		256.50

4.0 MIL

SPMWG43050N	30" X 50 yd	31¢		\$116.25
SPMWG45450N	54" X 50 yd	31¢		209.25

Walk On Graphic Kits

Walk-On Graphics floor decal system is excellent for advertising in supermarkets, toy stores, restaurants, theaters, or other high traffic areas where point of purchase displays are optimal. A two part, UL-approved system consisting of a base film, available in matte white, and a slip resistant overlaminate.

SPMSWOGFW5450N	54" X 50 yd	97¢		\$656.10
----------------	-------------	-----	--	----------



Liquid Laminates



HOT ITEM



Clear Jet® Solvent Base UV-Protective Coating

- High-performance
- Waterproof
- State-of-the-Art UV inhibitors, will not yellow
- Formulated for enhanced flexibility
- Dry to the touch in an hour
- Excellent on vehicle and fleet graphics
- No Clean-Up 12 oz Spray Cans covers 32-48 sq. ft.
- Use ClearJet® on most substrates, including canvas, vinyl (enamel receptive and non-enamel receptive), banners, fiberglass, wood, metal, plastic, and paper

SBCJ-GA2 Gloss Aerosol 12oz can .. \$10.99
SBCJ-SA2 Semi-gloss Aerosol ... 12oz can 10.99

(NOTE: Aerosols cannot be shipped via Air-Freight)

**Clear Jet® available in Brush & Roll
and Ready-to-Spray Formulas.**

CLEAR SHIELD Type VG

Vehicle Graphics Formula

BCGVG-QT Gloss qt \$31.99
BCGVG-GL Gloss gallon 93.99

Clear Shield® Waterbase UV-Protective Coating



- High-performance
- Highly-flexible
- Waterproof
- Contains state of the art UV inhibitors, will not yellow
- Excellent for non-water sensitive inks, media, materials, and products
- Easy clean up with soap and water

CLEAR SHIELD Original

Recommended for ecosolvent & solvent inks.

WBCG-QT Gloss qt \$24.99
WBCG-GL Gloss gallon 74.99
WBCSG-QT Semi-gloss qt 25.99
WBCSG-GL Semi-gloss gallon 76.99
WBM-QT Matte qt 27.99
WBM-GL Matte gallon 82.99

CLEAR SHIELD Type LL

Use with roller coasters or rod type automated liquid laminating equipment. For best results with hand application use high density foam roller.

WBCGLL-QT Gloss qt \$24.99
WBCGLL-GL Gloss gallon 74.99
WBCSGLL-QT Semi-gloss qt 25.99
WBCSGLL-GL Semi-gloss gallon 76.99
WBMLL-QT Matte qt 27.99
WBMLL-GL Matte gallon 82.99



Frog Juice

What is Frog Juice? Frog Juice is a relative to automotive clear and is a very glossy liquid laminate. It is totally synthetic and will not yellow, and does not require a

hardener or catalyst. It achieves maximum hardness slowly over a period of 30 days, yet is ready to handle and place outdoors in 30 minutes.

NOT FOR USE WITH DIGITAL BANNER MATERIALS.

CAUTION: Always test any Liquid Laminate in an inconspicuous area before using. And for the love of Pete, read the directions!

Sunscreen Clear 7000

Multi-purpose clear coat that is a UV protectant and designed to be used over digital printing. Can be applied directly to vinyl.

FJ7000-CL-QT Solvent-based \$27.00
FJ7000-CLWB-QT Water-based 27.00

Semi-Gloss Spray for Digital Prints

Similar qualities as the Clear 7000 with a semigloss finish. One can has the coverage of 25-40 ft². Solvent-based.

FJ7000-CL-SPRAY 12oz Aerosol \$8.95

(NOTE: Aerosols cannot be shipped via Air-Freight)

Lamination Film



VIZUONPRINT™



Clear LP3812

- 3.6 mil, calendered PSA lamination film
- Also can be used for digital printing
- **Glossy lamination film for LD3810G/M & LD383TG/M**
- Flat surfaces and simple corrugations
- Clear, solvent-based, permanent acrylic adhesive
- 83#, Double-side PE coated paper
- 3 years outdoors with proper application and lamination

GLOSSY

LP-3812G-3050	26¢/ft ²	30" x 50 yd	\$96.99
LP-3812G-5450	25¢/ft ²	54" x 50 yd	166.15
LP-3812G-6050	25¢/ft ²	60" x 50 yd	184.50

MATTE

LP-3812M-3050	26¢/ft ²	30" x 50 yd	\$96.99
LP-3812M-5450	25¢/ft ²	54" x 50 yd	166.15
LP-3812M-6050	25¢/ft ²	60" x 50 yd	184.50

Clear LP80990G

- 2.3 mil, cast PSA lamination film / also can be used for digital printing
- **Glossy lamination film for LD823TG**
- Flat surfaces and simple corrugations
- Clear, solvent-based, permanent acrylic adhesive
- Super Flat liner, double-side olefin coated paper
- 7 years outdoors with proper application and lamination

LP-80990G-3050	87¢/ft ²	30" x 50 yd	\$325.60
LP-80990G-5450	83¢/ft ²	54" x 50 yd	558.15
LP-80990G-6050	84¢/ft ²	60" x 50 yd	620.15

Clear LP3912

- 3.6 mil, calendered PSA lamination film
- Can be used for digital printing
- **Glossy lamination film for LD3910G/M & LD393TG/M**
- Flat surfaces and simple corrugations
- Clear, solvent-based, permanent acrylic adhesive
- 83#, Double-side PE coated paper
- 5 years outdoors with proper application and lamination

GLOSSY

LP-3912G-3050	33¢/ft ²	30" x 50 yd	\$124.00
LP-3912G-5450	32¢/ft ²	54" x 50 yd	212.65
LP-3912G-6050	32¢/ft ²	60" x 50 yd	236.25

MATTE

LP-3912M-3050	33¢/ft ²	30" x 50 yd	\$124.00
LP-3912M-5450	32¢/ft ²	54" x 50 yd	212.65
LP-3912M-6050	32¢/ft ²	60" x 50 yd	236.25

Optically Clear LP89000G

- 2.3 mil, cast PSA lamination film
- **Optically clear glossy lamination film for LM50000, LM53000**
- Flat surfaces and simple corrugations
- Clear, solvent-based, permanent acrylic adhesive
- PET liner
- 7 years outdoors with proper application and lamination

LP-89000G-4830	\$1.42/ft ² ..48" x 30 yd	\$512.30
LP-89000G-5430	\$1.42/ft ² ..54" x 30 yd	576.40



8518 3M Gloss Overlaminates

2.0 mil Gloss Cast Vinyl Overlaminates

8518-5425	77¢/ft ²	54" x 25y	\$258.50
8518-5450	77¢/ft ²	54" x 50y	485.65

8519 3M Luster Overlaminates

2.0 mil 3M Luster Cast Vinyl Overlaminates

8519-5425	82¢/ft ²	54" x 25y	\$276.75
8519-5450	82¢/ft ²	54" x 50y	553.25
8519-6050	82¢/ft ²	60" x 50y	614.75

CONVEX™ Clear Laminate 4-8mil

Adheres To Complex Curves

CVXOL4-2010	4mil, 20" x 10Y.....	\$1.12	\$56.00
CVXOL4-2050	4mil, 20" x 50Y.....	\$0.90	\$226.00
CVXOL4-3010	4mil, 30" x 10Y.....	\$1.13	\$85.00
CVXOL4-3050	4mil, 30" x 50Y.....	\$0.90	\$339.00
CVXOL8-2010	8mil, 20" x 10Y.....	\$1.40	\$70.00
CVXOL8-2050	8mil, 20" x 50Y.....	\$1.11	\$278.00
CVXOL8-3010	8mil, 30" x 10Y.....	\$1.48	\$111.00
CVXOL8-3050	8mil, 30" x 50Y.....	\$1.08	\$404.00

CONVEX™ Pro-Shield Laminate 7-12mil

Highly Durable, High Gloss Clear Laminate

CVXPS7-2010	7mil, 20" x 10Y.....	\$1.24	\$62.00
CVXRS12-2010	12mil, 20" x 10Y.....	\$1.82	\$91.00

Lamination Film



3mil Calendered Luster Film

This high-quality 3 mil calendered vinyl overlamine film is perfect for both indoor and some outdoor applications requiring less flexibility and durability than cast vinyl film. It offers a unique semi-gloss or luster look for glare-reduction. Performance is guaranteed for up to 25 months outdoors depending on the substrate and ink type used, either Roland pigment or mild solvent inks. This is a pressure-sensitive film that is also suitable for laminating other Roland media for added protection and durability.

PGM-OLCL-150-54 54'x150ft..... \$0.38/ft²..... \$255.99

2mil Premium Cast Glossy Film

This premium-quality 2 mil vinyl overlamine film is the perfect solution for all types of indoor and outdoor applications. It offers generous flexibility with a high gloss finish for maximum impact. Performance is guaranteed for up to 60 months outdoors depending on the ink type used, either Roland pigment or mild solvent inks. This is a pressure-sensitive film that is very durable and flexible, and is therefore suitable for laminating all other Roland media for added protection and durability.

PGM-OLPG2-150-30 .. 30"x150ft \$0.71/ft²..... \$267.99

PGM-OLPG2-150-54 .. 54"x150ft \$0.71/ft²..... 479.99

PGM-OLPG2-150-60 .. 60"x150ft \$0.71/ft²..... 531.99



1.5mil Ultra Conformable Cast Vinyl Film Permacolor RAYZor

- Clear permanent acrylic adhesive
- Available in Gloss
- Part of the B-free application warranty
- Optically clear protection for Perforated Window Film

LF-3642Gloss 30" X 150' \$0.69/ft² ... \$257.98

LF-3648Gloss 54" X 150' 0.66/ft² 447.99

3.0-3.2mil Intermediate Laminate MacTac ColorGard

- Available in Gloss, Matte, & Luster
- Great intermediate laminate solution

CG-7054Gloss 54" X 150' \$0.33/ft² ... \$222.75

CG-7254 Matte 54" X 150' 0.33/ft² 222.75

CG-7354 Luster 54" X 150' 0.33/ft² 222.75

High-Performance Rigid PS Overlamine 5mil Textured Vinyl PermaFlex

- Great for retractable banner stands and floor graphics
- For use with STR328 – STREET RAP
- UL Classified

PF-6314 Textured... 40.9" X 164' \$0.71/ft² ... \$394.34

PF-6315 Textured... 53.9" X 164' 0.71/ft² 515.77

Specialty Lamination Film



3.2mil Patterned Eclipse

- A new way to add dimension and eye appeal to your graphics
- Unique surface patterns alter light reflection and adds an exciting surface to work with
- Great for POP, displays, exhibits and store displays
- Permanent Clear Adhesive
- 5 New Patterns

Carbon Fibre Pattern

CARBFIBROL-5410 54" x 10Y... \$0.60/ft² \$79.25

CARBFIBROL-54150 .. 54" x 50Y.... 0.52/ft² .. **CALL** 351-00

Diamond Plate Pattern

DMNDPLATE-5410 54" x 10Y... \$0.60/ft² \$79.25

DMNDPLATE-5450 54" x 50Y.... 0.52/ft² .. **CALL** 351-00

Frost Pattern

FROST-5410 54" x 10Y... \$0.60/ft² \$79.25

FROST-5450 54" x 50Y.... 0.52/ft² .. **CALL** 351-00

Sparkle-Brite Pattern

SPRKLBR-5410 54" x 10Y... \$0.60/ft² \$79.25

SPRKLBR-5450 54" x 50Y.... 0.52/ft² .. **CALL** 351-00

Linen Pattern

LINEN-5410 54" x 10Y... \$0.60/ft² \$79.25

LINEN-5450 54" x 50Y.... 0.52/ft² .. **CALL** 351-00

Laminating Machines

Seal 62 Base

62" Heat Assisted Laminator

The Seal Base 62 will mount and laminate prints up to 61" wide. Its features include a heat assisted top roller, a 2" nip opening, a manual nip adjustment for precise operation and 16.4'/minute speed capabilities.

- Adjustable pressure and speed settings
- Heat assisted top roller for superb lamination
- Manual nip adjustment
- Robust, free standing design

SEAL62-BASE (62" width) Call For Pricing **\$10,046**
SEAL64610....Lower release liner takeup option **305**
SEAL64611.....Roll-to-roll option **1,733**



Seal 54 Base

54" Heat Assisted Laminator

The Seal Base 54 will mount and laminate prints up to 55" wide. Its features include a heat assisted top roller, a 2" nip opening, a manual nip adjustment for precise operation and 16'/minute speed capabilities.

- Adjustable pressure and speed settings
- Heat assisted top roller for superb lamination
- Manual nip adjustment
- Robust, free standing design

SEAL54-BASE (54" width) Call For Pricing **\$9,102**



Daige Quickmount 4

Affordable Cold Laminator

Laminate or mount your prints quickly and easily. Provides features found in more expensive laminators.

- Heavy duty motor
- Automatic take up shaft
- Silicone covered rollers
- Rugged steel and aluminum construction.

QM425 (25" width) \$1,295
QM438 (38" width) 1,495
QM455 (55" width) **CALL FOR PRICING** 1,995
QM465 (65" width) 2,400

FS - Footswitch \$55
ST4 - Stand \$195



Made in the U.S.A.

Rolls Roller Flatbed Laminator

SAVE TIME
No Bubbles • No Wrinkles

SAVE MONEY

Apply your graphics to your signage in a fraction of the time with a single operator!!!

DEMO: signandgraphicsupplies.com/flatbed

Transfer Application Tape to the Self-Adhesive Graphic, and the Self-Adhesive Graphic to the Substrate.

The **Rolls Roller Laminator** works both on rolled media offering a completely new production method with valuable advantages: Cost reduction in the production and the saving of man power. Therefore, the **Rolls Roller Flatbed Laminator** is a profitable investment for every graphic manufacturer and sign maker.

Model 280

- 1" MDF board table top, 98" x 48" operating area
- Roller with sliding mechanism and locking device.
- Pneumatic height adjustment of the roller.
- Storage rack underneath table.
- Mounted on steel wheels for easy mobility.

RR28050" Call For Pricing **\$19,850**



Model 540

- 1/2" glass table w/illuminated capability, 16' x 61" operating area.
- Roller with sliding mechanism and locking device.
- Pneumatic height adjustment of the roller, up to 2.75" as standard.
- Storage rack underneath and on the table sides.
- Mounted on steel wheels for easy mobility.

RR540 67" Call For Pricing **\$30,900**



Model Shown:
RSC-1650H

Model 1650

- Laminates up to 65" wide, at up to 16.4' per minute.
- Digital controls for temperature (RSC-1650H only) and speed to deliver a perfect finish. Silicone rubber rollers.
- Designed for mounting up to 5/8", laminating individual or multiple copies.
- Simple one button operation plus standard remote control and foot pedal allow hands-free operation.
- High quality silicone rubber rollers allow cold lamination for heat sensitive applications.

RSC-1650C 65" Cold Call For Pricing **\$7,865**

RSC-1650H .. 65" Heat Assist Call For Pricing **8,105**

Model Shown:
RSC-1400C

Model 1400

- Laminates up to 55" wide, at up to 16.4' per minute.
- Digital controls for temperature (RSC-1400H only) and speed to deliver a perfect finish. Silicone rubber rollers.
- Designed for mounting up to 5/8", laminating individual or multiple copies.
- Simple one button operation plus standard remote control and foot pedal allow hands-free operation.

RSC-1400C 55" Cold Call For Pricing **\$6,625**

RSC-1400H .. 55" Heat Assist Call For Pricing **7,790**

RSC-1400L .. 55" Large Roller Call For Pricing **7,790**

Same features as the RSC-1400C but 50% larger diameter rollers.



Roland Inkjet Printer/Cutters

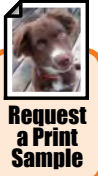

VersaUV LEC-300

HOT ITEM

The Green Machine

- World's first UV inkjet printer/cutter
- Ideal for proofs, packaging prototypes and short runs
- Industry's newest generation of UV inks
- Five-colors CMYK+White with Clear Coat. Layered clear coat produces unique textures and finishes
- Supports hundreds of media types including metallic papers, foils, film and flexible substrates

VersaUV LEC-330

Improved, versatile ink handling system

- New head configuration, print up to 101 ft²/hour
- Up to 1440x1440 resolution
- New automated intelligent ink circulation system
- CMYK+double White for higher white opacity (1.5x more opaque), or CMYK+double Clear for custom clear textures (for faux leather, or other applications), or CMYK+White+Clear for the best of both worlds
- Supports hundreds of media types including metallic papers, foils, film and flexible substrates

LEC-300 (30") Call For Pricing **\$52,495**

LEC-330 (30") Call For Pricing **\$62,995**



54" or 30" Available

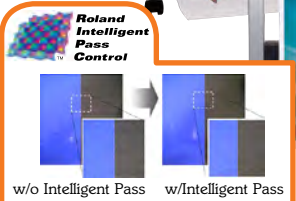

VersaCAMM® VPi

Enhanced VersaCAMM

HOT ITEM

- VPi-540 max. speed 149 ft²/hr
- VPi-300 max. Speed 113 ft²/hr
- 54" or 30" Maximum Media Width
- New Heavier Roll Capacity
- Multiple Pinch Rollers with Improved Feed
- Improved Ink Delivery System
- New Improved Media Flanges & Stoppers
- VersaWorks™ RIP software featuring Roland Color™

VPi-300 (30") Call For Pricing **\$16,595**

VPi-540 (54") Call For Pricing **22,995**

VersaCAMM® SPi

Standard VersaCAMM Model

- Print speeds up to 114 ft²/hour @ 360 dpi (SPi-540V)
63 ft²/hour @ 360 dpi (SPi-300V)
- ECO-SOL MAX inks, 4 colors (CMYK)/ 2 heads
- High-resolution printing (up to 1440x1440 dpi)
- Affordable price, with superior performance
- Roland VersaWorks™ RIP 3.0 included
- Ethernet Connectivity SP-540V
- USB Connectivity SP-300V

SPi-300V (30") Call For Pricing **\$12,495**

SPi-540V (54") Call For Pricing **17,895**



54" or 30" Available



800-646-6064

Roland SOLJET™ PRO III XC-540MT

With Vibrant Metallic Silver ECO-SOL MAX Inks

- 6-color CMYK+white+metallic silver printing
- Create 1000's of metallic/pearlescent colors
- Blazing print speeds (up to 441 ft²/hour in CMYK mode)
- Photo-realistic printing (up to 1440x1440 dpi)
- Automated ink circulation system
- Roland VersaWorks™ RIP 3.0 included

ROL-XC540MT (54") .. Call For Pricing **\$39,995**



Roland SOLJET™ PRO III XC-540

Our Best Printer/Cutter

HOT ITEM

- Blazing print speeds (up to 441 ft²/hour)
- ECO-SOL MAX inks, 6 colors (CMYKLCm)
- Photo-realistic printing (up to 1440x1440 dpi)
- Automated take-up system
- Roland VersaWorks™ RIP 3.0 included

ROL-XC540 (54") Call For Pricing **\$31,495**



Large Format Printers

Roland PRO III XJ Series

Exceptional Speed & Quality

Experience outstanding all-around performance with the new PRO III XJ series, our fastest SOLJETs yet. Available in 74", 64" and 54" models, these powerful printers combine high-speed productivity with precision image quality for the ultimate in 6-color digital printing.



SHOWN WITH OPTIONAL DRYER BLOWER SYSTEM



SHOWN WITH OPTIONAL DRYER BLOWER SYSTEM



Request a Print Sample

- Fast print speeds
458 ft²/hr. for the 74" XJ-740
449.5 ft²/hr. for the 64" XJ-640
441 ft²/hr. for the 54" XJ-540
- Choice of 440 or 220ml ink cartridges
- True Photo-realistic printing (up to 1440 dpi)
- Automated take-up system included
- Variable droplet technology for crisp detail
- Ethernet Connectivity
- Roland VersaWorks™ RIP 3.0 included

XJ-540 (54")..... Call For Pricing **\$26,295**
XJ-640 (64")..... Call For Pricing **29,395**
XJ-740 (74")..... Call For Pricing **31,495**

Roland Wide Format Printers

MORE **PROFESSIONALS** CHOOSE ROLAND

Roland AdvancedJet AJ-1000i

Fast, Most Versatile Printer



- Breakneck print speeds (up to 968 ft²/hour)
- **EcoXtreme** or **EcoXtreme LT** inks, 6 colors (CMYKLcLm)
- Photo-realistic printing (up to 720 dpi)
- Automated media feed and take-up system
- New high-capacity ink delivery system
- Automated intelligent maintenance system
- Integrated tri-heater and blower system
- Ethernet 10 Base-T/100 Base-TX built-in
- Roland VersaWorks™ RIP 3.0 included



ROL-AJ1000i (104" width) Call For Pricing **\$62,995**

Roland AdvancedJet AJ-740i

Blazing Industrial Speed



Engineered for performance, Roland's newest 74" AdvancedJET brings blazing print speeds and a host of productivity tools to today's fast-paced, high-volume, on-demand market. Creates brilliant outdoor banners and vehicle graphics. Integrated tri-heater and blower print-drying system comes standard!

- Ethernet Connectivity
- Fast print speeds (up to 871 ft²/hour)
- **EcoXtreme** or **EcoXtreme LT** inks, 6 colors (CMYKLcLm)
- Automated, heavy-duty media handling system
- Variable droplet technology for crisp detail
- Roland VersaWorks™ RIP 3.0 included



AJ-740i (74") Call For Pricing **\$47,295**

Roland VersaArt RS

HOT ITEM

Economical Roland Printing



The VersaArt RS series of eco-solvent wide-format printers integrates the latest technologies from Roland's award-winning VersaCAMM and SOLJET PRO III models. Offered in 54" and 64" 4-color (CMYK) models, the VersaArt is the perfect production tool for both indoor and outdoor graphics including signs, POP/POS materials, banners, posters, vehicle graphics and wraps. It also supports soft signage and fabric applications.

- Complete print/cut solution
- Roland Intelligent Pass Control technology
- Eliminates banding in virtually every print mode
- Max print speeds approx. 225 ft²/hour
- ECO-SOL MAX (CMYK), 440 or 220 ml ink cartridges
- Outstanding image quality up to 1440x720 dpi
- Roland VersaWorks™ RIP 3.0 included
- Supports heavy media rolls



RS-540 (54") Call For Pricing **\$16,295**

RS-640 (64") Call For Pricing **17,895**



800-646-6064

Roland Large Format Printers

On Site Installation and Training

HI-FI PRO FJ Series

Exceptional Print Quality & Color

- Fast print speeds (up to 300 ft²/hour at 450 dpi)
- Choice of pigmented or dye-based inksets
- True Photo-realistic printing (up to 1440 dpi)
- Automated media handling system
- Variable droplet technology for crisp detail
- Ethernet Connectivity
- Roland VersaWorks™ RIP 3.0 included

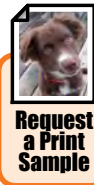

54" media width

FJ-540 (54") Call For Pricing \$23,095

HI-FI Express FP Series

Bold & Crisp Dye-Sublimation Graphics

- High-volume production (up to 548 ft²/hour at 270x360 dpi at 2 pass)
- Extended Capacity Ink Delivery System
- Capable of printing up to 720 dpi
- Automated media take-up system
- Ethernet Connectivity
- Roland VersaWorks™ RIP 3.0 included



74" media width

FP-740 (74") Call For Pricing \$41,995

Roland Accessories

Blower/Dryer Kits

- DU-540 for XJ/XC-540 \$3,144.75
- DU-640 for XJ-640 3,459.75
- DU-740 for XJ-740 3,669.75

Mesh Unit

- MU-740 for AJ-740 3,144.75
- MU-1000 for AJ-1000 \$4,089.75

Media Take Up Bar/Rail

- TU2-30 for VersaCAMM 30" \$2,094.75
- TU2-54 for VersaCAMM 54" 2,094.75
- TU2-64 for VersaCAMM 64" 2,094.75
- TU2-74 for 700 Series 74" 2,094.75

Eliminate Static, Improve Printing!

Wide Format StopStatic™ Kit

StopStatic™ is a trademark of Alpha Innovation, Inc.

Contains 1 roll of Static Elastic™ (total of 36', 11 meters fully extended) and 6 mounting Magnets. **The Static Elastic™ removes static from materials before they enter the print area, eliminating dust attraction and printing defects such as threading and fogging.**

WFSK.....\$129.00/kit



(Magnets attach Static Elastic™ to machine)



Directions:

1. Place Static Elastic™ across the sheet as shown and ground it to the bare metal of the machine.
2. Adjust the distance from the charged sheet or web from direct contact to up to two inches away.

STOP STATIC.COM

Static Elastic™ can be placed on either side of the sheet after printing, to prevent dust.

Roland Vinyl Cutters

We're a Roland Authorized Service Center
Ask about our printer & cutter
EXTENDED WARRANTY

- **Speed**
- **Power**
- **Precision**

Roland professional grade cutters make it fast and easy to contour cut full color pre-printed graphics. Window tints, stencils, vehicle graphics, pin-stripping, and heat transfer t-shirt graphics come out crisp and clean, time and time again...

Roland GX Pro Cutter Sign Maker Professional Sign Making Series

CAMM-1 PRO
by Roland DG Corporation



- Cuts up to 33 in/sec.
- 350 grams max. down force for cutting through heavier materials
- Optical registration for accurate contour cutting
- USB and Serial connectivity
- Roland CutStudio™ Software

GX-300 (30") Call For Pricing **\$3,495.00**
GX-400 (40") Call For Pricing **\$4,495.00**
GX-500 (50") Call For Pricing **\$5,495.00**

CAMM-1 by Roland DG Corporation GX-24 DESKTOP CUTTER 24" Cutting

- Cuts up to 20 in/sec.
- 250 grams max. down force
- Optical registration
- Roland CutStudio™ Software

GX-24.... Call for Price **\$2095.00**

Stands for the GX-24
GXS-24.... Call for Price **295.00**



★ DESIGN CUTTER
STIKA

STIKA® PORTABLE CUTTER Affordable Cutting

- Compact, light-weight design
- USB connectivity
- Roland CutStudio™ Software

SV-8 (8") Call For Pricing **\$525.00**
SV-12 (12") Call For Pricing **735.00**
SV-15 (15") Call For Pricing **1,045.00**

Roland

Roland EGX-350

Easy to Use Desktop Engraver



Create beautiful custom signs and nameplates. Or produce design templates for heat pressing rhinestones onto t-shirts, handbags and other apparel items. The EGX-350 easily handles a wide variety of materials, including plastic, acrylic, aluminum, stainless steel, brass and wood. Unlike laser engravers, the EGX-350 preserves the original colors and textures of wood, brass and artificial marbles.

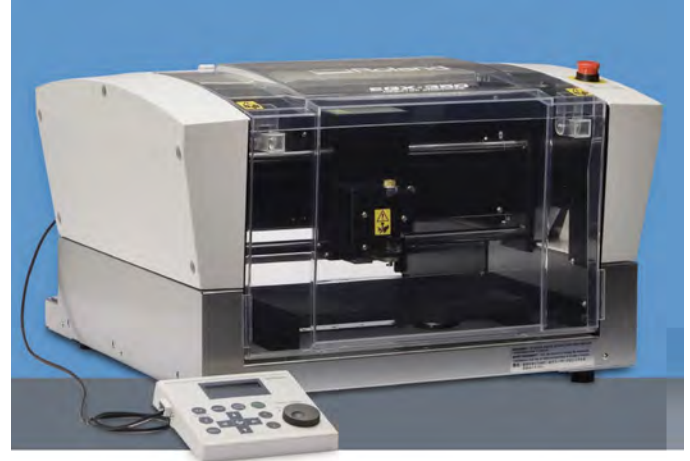

EGX-350..... Call For Pricing **\$5795.00**

EGX-350 Accessories..... Call For A List

Roland R-WearStudio Software

- Drawing tools for drawing print objects, engrave objects and cut lines
- Automatic rhinestone arrangement
- Includes a library of approximately 500 Swarovski rhinestones
- Allows you to calculate and control rhinestone inventory
- SFEdit2 stroke font editor software which allows the conversion of outline to stroke

RWSTUDIO Stand Alone\$499

RWSTUDIO-BUN Bundled w/ EGX-350\$299



Metaza MPX-80

Fast, Easy Personalization

Turn ordinary gift items, awards and jewelry into beautiful personalized mementos with the new MPX-80 - our fastest impact printer yet and a great profit center for retailers everywhere.

- Personalize wide range of jewelry, gifts and awards
- Imprint curved objects like pens, cuff links & money clips
- Vector support to produce crisp line art, fonts and logos
- Resolutions up to 529dpi
- Imprint acrylic, aluminum, stainless steel, brass, gold, silver, platinum and metallic stickers
- MPX-80 maximum material size: 100mm x 100mm x 40mm
- Design software included

MPX-80..... Call For Pricing **\$3,695.00**

METAZA

• METAL PRINTER •



Roland Maintenance & Consumables



Swabs

Swab Kit Qty 50, 5in Swabs (InkJet)
IJ-SWABKIT5-50 \$19.00

Wiper

Wiper Head. Wipes your printhead clean.



WIPER \$12.60
SR-WIPER 19.00
WIPER-AJ1000 .. (for AJ-1000) 27.10

Scrapers

Wiper Scraper (VP, XC)



SCRP-BLK black \$6.00
 Wiper Scraper (Pro II & III, VersaCamm SP)
SCRP-CLR clear 3.30
 Wiper Scraper, AJ-1000
SCRP-AJ1000 11.00



Mist Pads & Wicks

Sergemist pads and inner pads

VCSP-MISTPAD Mist Pad \$2.60
VCSP-WICK Wick 2.60
VCSP-PADUNDER Pad 6.30



PRO-MISTPAD Mist Pad \$2.50
PRO-WICK Wick 2.10

Maintenance Fluid

Cleaning Fluid For SolJet

US-CLNFLDSJ-4 4oz. Bottle \$26.95
US-CLNFLDSJ-500 500ml. 70.90

Cleaning Cartridges

Maintenance Cartridge Solvent Ink

AI-ML AJ-1000 only \$169.99
 Cleaning Cartridge Sol/EcoSol Ink
SL-CL 52.95
 Cleaning Cartridges 4pk (SolJet Pro II/III)
SL-CLSET-4 185.95



Capping Tool

Pipe Tool for certain Roland printers
CAPTOOL \$10.50



Cap Top Assembly

CAPTOP \$25.00
CAPTOP-AJ1000 77.50

Media Clamps

Includes entire assembly unit.

KC-540
MC-R-XC540 \$64.90
MC-L-XC540 64.90
SP-300V/SP-540V
MC-RSHORT-SPV 35.00
MC-LSHORT-SPV 35.00
MC-RLONG-SPV 35.30
MC-LLONG-SPV 35.30
VP300/VP-540
MC-RSHORT-VP 35.00
MC-LSHORT-VP 35.00
MC-RLONG-VP 63.00
MC-LLONG-VP 63.00
SP-300
MC-RSHORT-SP300 26.10
MC-LSHORT-SP300 26.10
MC-RLONG-SP300 26.50
MC-LLONG-SP300 26.50

KJ-540/640/740

MC-R-XJ 153.10
MC-L-XJ 153.10

SC-540(EK)/545EK

MC-RLS-SC 12.90
 Includes 2 sliders

Flanges

Guides for accurate media feed. Fit's 2" or 3" cores. Expandable cuff for 3" cores!



FLANGE each \$31.50



Cutter Protection Strips

XD-CPS-GX3 GX-300 \$10.00
XD-CPS-GX4 GX-400 10.00
XD-CPS-GX5 GX-500 10.00
XD-CPS-5
 PNC-5000/PC-50/60/CM/CX-24 9.99
XD-CPS-6 CM-12/CX-12 7.50
XD-CPS-7 STX-7 4.99
XD-CPS-8 STX-8 4.99
XD-CPS-9 PNC-900 7.50
XD-CPS-12 PNC-1200 9.99
XD-CPS-X8 SX-8/SV-8 9.99
XD-CPS-X12 SX-12/SV-12 9.99
XD-CPS-X15 SX-15/SV-15 9.99
XD-CPS-24 GX-24 12.30
XD-CPS-30
 CM-300/PC-600/CX-300 9.99
XD-CPS-40 CM/CX-400 9.99
XD-CPS-50
 CM/CX-500/SP-540 12.50
XD-CPS-60 PC-12 10.00
XD-CPS-91 PNC-910 7.50
XD-CPS-95 PNC-950 9.99
XD-CPS-96 PNC-960 9.99
XD-CPS-121 PNC-1210 9.99
XD-CPS-141 PNC-1410 9.99
XD-CPS-185 PNC-1850 12.50
XD-CPS-186 PNC-1860 12.50
XD-CPS-300 SP-300 9.99
XD-CPS-500 CJ/SC-500 13.50
XD-CPS-540 CJ/SC/XC-540 13.50
1000002598 VP-540 16.10
1000002656 VP-300 12.00

Tool Holders

Adjustable tip blade holder, CJ/SC/SP models, alloy

XD-CH2 \$69.99

Adjustable tip blade holder, CJ/SC/SP models, ceramic

XD-CH3 49.99

Sheet Cut Blades

KB Precision art knives (25/pk) .. \$4.25
KB4-S Precision art knives (5/pk) 3.40

Inks Roland

Eco-Sol Max Ink



ECO-SOL MAX for the Roland SoLJET and VersaCAMP range features significant new enhancements including faster drying time, improved scratch resistance, higher density, wider colour gamut and performance with both coated and uncoated substrates including 150 types of low-cost uncoated media. Low-maintenance ECO-SOL MAX is virtually odourless and does not require any special ventilation or environmental equipment. Choose ECO-SOL MAX for crisp graphics that last up to three years outdoors without lamination.

- Quick drying time
- Better scratch resistance
- Wider color gamut
- Virtually odorless
- 3-yr outdoor (w/o lamination)
- Eco-friendly

ESL3-BK , 220ml, Black	\$69.99
ESL3-CY , 220ml, Cyan	69.99
ESL3-LC , 220ml, Light Cyan	69.99
ESL3-LM , 220ml, Light Magenta	69.99
ESL3-MG , 220ml, Magenta	69.99
ESL3-YE , 220ml, Yellow	69.99

ESL3-MT , 220ml, Silver	\$229.99
ESL3-WH , 220ml, White	99.99
ESL-WH , 220ml, White (for SC only)	119.99

ESL3-4BK , 440ml, Black	\$128.99
ESL3-4CY , 440ml, Cyan	128.99
ESL3-4LC , 440ml, Light Cyan	128.99
ESL3-4LM , 440ml, Light Magenta	128.99
ESL3-4MG , 440ml, Magenta	128.99
ESL3-4YE , 440ml, Yellow	128.99

EcoXtreme and EcoXtreme LT Inks Roland

AI3-CY , 1000ml	\$199.99	AI2-CY , 1000ml	\$129.99
AI3-MG , 1000ml	\$199.99	AI2-MG , 1000ml	129.99
AI3-YE , 1000ml	\$199.99	AI2-YE , 1000ml	129.99
AI3-BK , 1000ml	\$199.99	AI2-BK , 1000ml	129.99
AI3-LC , 1000ml	\$199.99	AI2-LC , 1000ml	129.99
AI3-LM , 1000ml	\$199.99	AI2-LM , 1000ml	129.99

EcoXtreme solvent ink (AI3) for the Roland AJ-1000 AdvancedJET was developed for industrial-strength performance. It comes in 6 vivid colors (CMYK+LcLm) for exceptional gamut, high color density and unmatched durability, even in high-speed modes.

EcoXtreme LT ink (AI2) performs across a wide range of coated and uncoated media. Its rugged scratch, alcohol, water and UV resistance delivers vibrant prints that last up to 3 years outdoors.

Not suitable for Roland SoLJET or VersaCAMP.

EcoUV The most advanced UV inks

Packaged in no-mess 220ml cartridges, ECO-UV ink is VOC-free and safe after curing.

EUV-BK , 220ml	\$89.99	EUV-MG , 220ml	\$89.99
EUV-CY , 220ml	89.99	EUV-WH , 220ml	89.99
EUV-GL , 220ml	89.99	EUV-YE , 220ml	89.99

Sublimation Inks

High capacity 1 liter bottles for dye sublimation printers. Also available smaller cartridges. Call for information.

SBL2-BK , Black	\$214.99	SBL2-MG , Magenta	\$214.99
SBL2-CY , Cyan	214.99	SBL2-YE , Yellow	214.99

Aqueous Inks

- Exceptional print quality for photographic and fine art giclée, backlits, and other indoor applications
- Simulates 97% of Pantone® colors
- 100+ yr indoor durability

Dye Ink

FDY-CY , 220ml, Cyan	\$104.99
FDY-MG , 220ml, Magenta	104.99
FDY-YE , 220ml, Yellow	104.99
FDY-BK , 220ml, Black	104.99
FDY-LC , 220ml, Light Cyan	104.99
FDY-LM , 220ml, Light Magenta	104.99

Pigment Ink

FPG-BK , 220ml, Black	\$117.99
FPG-CY , 220ml, Cyan	117.99
FPG-GR , 220ml, Green	117.99
FPG-LC , 220ml, Light Cyan	117.99
FPG-LM , 220ml, Light Magenta	117.99
FPG-MG , 220ml, Magenta	117.99
FPG-OG , 220ml, Orange	117.99
FPG-YE , 220ml, Yellow	117.99



Thermal Transfer Ribbon

Quality ribbons for Gerber Edge® & Edge2® printers.



ZeroNine
THERMAL TRANSFER RIBBON®

ZeroNine NexGen Foils

Process (50yd Rolls)

- ZNG303PCY Process Cyan
- ZNG302PMG Process Magenta
- ZNG301PYE Process Yellow
- ZNG300PBK Process Black

Spot (50yd Rolls)

- ZNG248OB Olympic Blue
- ZNG227IB Intense Blue
- ZNG215RB Reflex Blue
- ZNG236CB Cobalt Blue
- ZNG206DR Dark Red
- ZNG226TR Tomato Red
- ZNG217BR Bright Red
- ZNG220B Brown
- ZNG241Y Yellow
- ZNG222BY Bright Yellow

- ZNG245SY Sunflower Yellow
- ZNG213BO Bright Orange
- ZNG242G Green
- ZNG207KG Kelly Green
- ZNG252JB Jet Black
- ZNG230LG Lite Gray
- ZNG201W White
- ZNG204TW Tinting White
- ZNG225FS Frog Skin™ Clear

Special Spot (50yd Rolls)

- ZNG224TB True Blue
- ZNG216MB Midnight Blue
- ZNG237P Purple
- ZNG219V Violet
- ZNG266CR Cherry Red
- ZNG243O Orange

- ZNG239B Beige
- ZNG211B Burgundy
- ZNG221LG Lime Green
- ZNG212FG Forest Green
- ZNG232DG Dark Gray
- ZNG214IL Intense Lime
- ZNG231MG Medium Gray
- ZNG208PO Pumpkin Orange
- ZNG235RR Rubine Red
- ZNG247WR Warm Red

	50 Yd Refill
PROCESS	\$60.59
STANDARD SPOT	58.40
SPECIAL SPOT	75.87

Process (100yd Rolls)

- ZNG503PCY Process Cyan
- ZNG502PMG Process Magenta
- ZNG501PYE Process Yellow
- ZNG500PBK Process Black

Spot (100yd Rolls)

- ZNG406DR Dark Red
- ZNG413BO Bright Orange
- ZNG415RB Reflex Blue
- ZNG417BR Bright Red
- ZNG422BY Bright Yellow
- ZNG425CL Frog Skin™ Clear
- ZNG426TR Tomato Red

- ZNG427IB Intense Blue
- ZNG436CB Cobalt Blue
- ZNG452JB Jet Black

	100 Yd Refill
PROCESS	\$115.46
STANDARD SPOT	111.26
SPECIAL SPOT	142.02

Special Spot (100yd Rolls)

- ZNG414IL Intense Lime

ZeroNine Legacy Foils

FOR USE IN GERBER EDGE THERMAL PRINTERS

Process & Spot (50 Yard Rolls)

- Z9F300PBK Process Black
- Z9F301PYE Process Yellow
- Z9F302PMG Process Magenta
- Z9F303PCY Process Cyan
- Z9F222BY Brite Yellow
- Z9F210MY Medium Yellow
- Z9F212AFG Forest Green, (Gerber Match)
- Z9F250SOBK Super Opaque Black
- Z9F200BK Black
- Z9F225AFC Semi Gloss Clear
- Z9F228SR Safety Red
- Z9F206DR Dark Red

Mirror & Gold Finish (25/50 Yard Rolls)

- Z9F234AMS 25 yd - Mirror Silver *
- Z9F233AMG 25 yd - Mirror Gold *
- Z9F234MS 50 yd - Mirror Silver *
- Z9F233MG 50 yd - Mirror Gold *

	50 Yd Refill	100 Yd Refill
PROCESS	\$56.10	\$109.28
STANDARD SPOT	56.10	109.28
SPECIAL SPOT	67.31	n/a
NEON COLOR	36.04	n/a

Process & Spot, Jumbo (100 Yard Rolls)

- Z9F500JPBK Process Black
- Z9F501JPYE Process Yellow
- Z9F502JPMG Process Magenta
- Z9F503JPCY Process Cyan
- Z9F400JBK Black
- Z9F406JDR Dark Red
- Z9F422JYE Brite Yellow
- Z9F426JTR Tomato Red
- Z9F450JSOB Super Opaque Black

	25 Yd Refill	50 Yd Refill
MIRROR FINISH	\$82.68	\$155.02

Special Spot (50 Yard Rolls)

- Z9F265T Turquoise
- Z9F244PB Peacock Blue
- Z9F209BB Brite Blue
- Z9F238PE Periwinkle
- Z9F237PU Purple
- Z9F240PY Pale Yellow
- Z9F261A Apricot
- Z9F260L Lilac
- Z9F600RP Ruby Positive *
- Z9F263DG Dolphin Green
- Z9F264M Mint
- Z9F205SC Shadow Cast

Neon (25 Yard Rolls)

- Z9F152NP Neon Pink *
- Z9F153NG Neon Green *

Misc.

- Z9F901..... Shuttle Cartridge \$29.95
- Z9F900..... Recycled Cartridge..... 9.95
- Z9FC1..... Color Chart Set - Printed On Vinyl..... 1.00

* Recommended For Indoor Use Only.

Thermal Transfer Ribbon



Quality ribbons for Gerber Edge FX® printers.

ZeroNine offers thermal transfer ribbons specifically for use on the Gerber EDGE® FX printer. ZeroNine's FX refill ribbons are wound onto 1.5" diameter cores and are available in a range of NexGen and Legacy colors.

When you order our FX refill kits, we send the feed and take up core along with the endcaps pre-



inserted. This convenes gives our customers a true drop-in solution into the OEM FX cartridge. Our FX refill kits are direct replacements from the OEM ribbons and are intentionally designed to work in the EDGE® FX Caddy supplied by the OEM.

Part numbers that begin with a G use our new NexGen Ribbon Chemistry. Part numbers that begin with an F use our original Legacy formulation. Feel free to contact us if you have any questions.

ZeroNine NexGen Foils

- Process** (50yd Rolls)
- G300FX** Process Black
 - G301FX** Process Yellow
 - G302FX** Process Magenta
 - G303FX** Process Cyan

- Spot** (50yd Rolls)
- G252FX** Jet Black
 - G225FX** FrogSkin
 - G201FX** White
 - G222FX** Brite Yellow
 - G241FX** Yellow
 - G245FX** Sunflower Yellow
 - G213FX** Bright Orange

- G217FX** Bright Red
- G226FX** Tomato Red
- G206FX** Dark Red
- G236FX** Cobalt Blue
- G215FX** Reflex Blue
- G227FX** Intense Blue
- G248FX** Olympic Blue
- G223AFX** Teal
- G242FX** Green
- G207FX** Kelly Green
- G220FX** Brown
- F203FX** Metallic Gold
- F202FX** Metallic Silver

- Special Spot** (50yd Rolls)
- G221FX** Lime Green
 - G214FX** Intense Lime
 - G212FX** Forest Green
 - G216FX** Midnite Blue
 - G243FX** Orange
 - G247FX** Warm Red
 - G266FX** Cherry Red
 - G235FX** Rubine Red



- Process** (100yd Rolls)
- G500FX** Process Black
 - G501FX** Process Yellow
 - G502FX** Process Magenta
 - G503FX** Process Cyan

- Spot** (100yd Rolls)
- G452FX** Jet Black
 - G425FX** FrogSkin
 - G422FX** Brite Yellow
 - G436FX** Cobalt Blue

- Special Spot** (100yd Rolls)
- G414FX** Intense Lime

	50 Yd Refill	100 Yd Refill
PROCESS	\$62.10	\$118.35
STANDARD SPOT	59.86	114.04
SPECIAL SPOT	77.77	145.57

ZeroNine Legacy Foils FOR USE IN GERBER EDGE THERMAL PRINTERS

- Process** (50yd Rolls)
- F300FX** Process Black
 - F301FX** Process Yellow
 - F302FX** Process Magenta
 - F303FX** Process Cyan

- Spot** (50yd Rolls)
- F200FX** Spot Black
 - F250FX** Super Opaque Black
 - F203FX** Metallic Gold
 - F202FX** Metallic Silver

- Process** (100yd Rolls)
- F500FX** Process Black
 - F501FX** Process Yellow
 - F502FX** Process Magenta
 - F503FX** Process Cyan

- Spot** (100yd Rolls)
- F400FX** Spot Black

	50 Yd Refill	100 Yd Refill
PROCESS	\$57.50	\$112.01
STANDARD SPOT	57.50	112.01

Blades Roland



45° Blades

.25 offset (Cast & Calendered Vinyl)
USA-C145-1 \$18.99/1pk
USA-C145-3 44.99/3pk
USA-C145-5 69.99/5pk

60° Carbide

.50 offset (Reflective Vinyl, Flock, Twill, Paint Protection Film)
USA-C160-1 \$21.99/1pk
USA-C160-3 45.99/3pk

60° Cemented Carbide

.50 offset (for thick material and sandblast stencil)
ZEC-U3050-1 \$35.99/1pk
ZEC-U3050-3 98.99/3pk
ZEC-U3050-5 149.99/5pk

GAP Plotter Blades

SC-1000 Carbide Series

• Gerber III/IV, S/750, Sprint Series, Lettersmith, GS15 Plus • Anagraph Excel 1/1m • Compugraphicarty
 30° SC-1030
 45° SC-1045
 60° SC-1060 \$11.00



SC-1800 Carbide Series

• Sungraf / Graphityp 19-D / 30-D
 26° SC-1826 (Yellow)
 40° SC-1840 (Red)
 59° SC-1859 (Blue) \$31.50



SC-3300 Carbide Series

• Summagraphics D-Series
 • GRI
 35° SC-3335
 60° SC-3360 \$13.70



Standard Gerber Config Carbide G-Series

• Gerber III/IV, S/750 Sprint Series Lettersmith • Anagraph Excel 1/1m • Compugraphicarty
 30° G-30
 45° G-45
 60° G-60 \$7.15

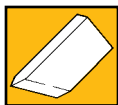

SC-1900 Carbide Series

• American Graphotec Cutting Pro / FC-Series • Nova Cut
 45° SC-1945
 60° SC-1960 \$17.50

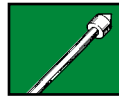

SC-3600 Carbide Series

• Anagraph AE-Series
 • Elite
 45° SC-3645
 60° SC-3660 \$19.50



SC-1300 Carbide Series

• All Roland • Allen Datagraph 936/800 • CSR Ecom-2 • Anagraph - EMS • Vinyl Express • Lynx • Panther
 30° SC-1330
 45° SC-1345
 60° SC-1360 \$19.50



SC-2000 Carbide Series

• Mimaki CG-Series • New Star • DGI Omega
 37° SC-2037 (Type 1)
 40° SC-2040 (Type 3)
 56° SC-2056 (Type 5) \$20.00



SC-3800 Carbide Series

• Mutoh XP-Series • Gerber Emboss Track, Odyssey • P-Cut 630 Creation
 30° SC-3830
 45° SC-3845
 60° SC-3860 \$20.00



SC-1400 Carbide Series

• Ioline Studio 7/8 Artpro Series / Super 88 / Smartrac (small blade) • Techno-Arts Switchblades • Classic • K-Cad-RBL-C
 30° SC-1430
 45° SC-1445
 60° SC-1460 \$14.00



SC-2945 Carbide Blade

• All Roland
 • Allen Datagraph 936 / 800
 • CSR Ecom-2
 45° SC-2945 \$23.55



SC-4100 Carbide Series

• Mutoh SC-Series • Gerber Fast Track
 30° SC-4130
 45° SC-4145
 60° SC-4160 \$17.50



SC-1500 Carbide Series

• Ioline 5000 • Techno-Arts Bladerunner • Signature 45
 30° SC-1530
 45° SC-1545
 60° SC-1560 \$10.00



SC-3000 Carbide Series

• Summagraphics T-Series (Insert Blade Holder)
 36° SC-3036
 60° SC-3060 \$28.75



SP-9000 Pen Series

• Graphix 4 / 4B / 4E • Gerber Sprint • Gerber S / 750 • Gerber Graphix 2 • Anagraph Excel 1 1m
 Black SP-9001
 Blue SP-9002
 Red SP-9003 \$30.85



Services

Equipment Installation

Take comfort in knowing when Aksarben installs a Roland printer for your company, you will receive a professional set up and thorough training in printer maintenance and functionality as well as complete training in the Roland VersaWorks RIP. Be as self reliant as you can be with tricks of the trade and set up features, provided by Aksarben Sign & Graphic Supplies, that will allow your company be more productive.



Printer Repair

Nebraska's original Roland dealer! We have 2 Roland Certified Service Technicians on staff with over 12 years of combined training and experience, servicing Roland equipment; Current Printers and Printer/Cutters as well as Legacy models.

Cutter Repair

Aksarben Sign & Graphic Supplies is a Roland Certified Cutter Service Center. Send your Roland Cutter to Aksarben. We will return your cutter to the original working condition of the reliable Roland you have grown to trust.

AKSARBEN Custom Sewn Blank Banners

Check out our Web Site for the latest colors and prices available.

We also do Custom Sign Covers, Break Away Banners, Pennant Banners & More! Let the Pros finish your Digital Banners as well! No quantity is too large or too small. With over 22 years experience, our staff can provide a fast turn around time while taking the best care of your Digital Banners. Call for quotes.

Customize Size Cut to YOUR widths!



Have a custom width? Let us know and we will custom cut any of our rolled goods; banner, pressure sensitive vinyl or tape to your specified sizes. How about sheet substrates? Call an Aksarben Sign & Graphic Supplies representative to discuss your converting specifications.

Grommet Services

Custom grommeting can be done in a portion of the time as hand grommeting, with our self-feeding pneumatic grommet machines.





Lamination is a GREAT way to protect and present an image.

Did you know that...

- Over-laminates should match the media. Vinyl to vinyl, polyester to polyester.
- Over-laminates should be the same thickness, or thinner, than the imaged product.
- A UV laminate can extend the image life by 3 to 4 times.
- Cloudy lamination is a result of insufficient heat.
- Silvering is caused by an adhesive not wetting out.
- Over-laminating one side with too much pressure can cause the image to curl toward the laminated side and the edges to lift.
- Leaving unprinted media leader in front of your image will provide the opportunity to look for wrinkles prior to the image lamination.
- Wait at least 1 hour before trimming the laminate. Media bond will strengthen over time.



For more Lamination Tips visit this link:

http://www.magicinkjet.com/files_technical_bulletins.html

Tips for Pressure-Sensitive Adhesive Applications

- Ensure the desired surface is cleaned, free of dust, dirt, and cleaner residues.
- Painted metal, glass, and art mounting boards should be cleaned with glass cleaners or isopropyl alcohol (IPA).
- Apply to smooth flat surfaces such as stainless steel, glass, acrylics, ABS, polycarbonate, Plexiglas®, Fome-Cor®, and Sintra®.
- Always pretest your application surface prior to installation.
- Trim the print ½" from the edge or use a commercial edge sealer.
- Prints may be protected with an over-laminate; however, over-laminating one side may cause the product to curl towards the laminated side.
- Dry application is recommended.
- PSA removal may require physical scraping or use of solvents.
- Insert a sharp knife or razor under a corner of the graphic and peel the graphic carefully.
- Remove residue by picking with the adhesive side of the removed graphic.
- Any remaining residue may be removed by using a mild solvent such as isopropyl alcohol or ethanol.

Training

For Class Information, Dates and Locations:
Call Aksarben Sign & Graphic Supplies at 800-646-6064

Roland UNIVERSITY



Born to Wrap Workshop

Two-day workshop. Learn firsthand from Roland specialists and industry professionals to take a vehicle graphics job from design to installation.

- Important points of any vehicle graphic design
- File setup and graphic design
- Color matching and print/cut/laminate workflow
- Job estimation and real-world costs
- Sales & advertising techniques
- Vehicle preparation and application techniques
- Hands-on graphic installation & removal

X-Rite Roland Color Workshop

One-day workshop will teach clear step-by-step color management strategies to increase your productivity, avoid common pitfalls, and experience better color output than ever before. Get rich, dense colors and flawless image quality every time you print with your Roland wide-format inkjet.

This course will specifically focus on the fine points of color management in conjunction with the Roland VersaWorks' color management engine.

- Color theory and digital printing basics
- Workflow color management
- Unique RIP color management settings
- Matching color between printers and media
- Color measurement devices and custom profiles
- Display profiles for soft proofing

Productivity Workshop

The Roland Productivity Workshop is designed for users of Roland's VersaCMM, PRO II or PRO III print or print/cut devices who want an in-depth training on how to increase productivity, maintain their printer, and prolong the performance of their versatile Roland equipment.

This action-packed one day event will help you establish a consistent color workflow between your graphics applications and Roland VersaWorks, ultimately maximizing the output performance of your solution - Roland VersaWorks and your Roland printer or printer/cutter.

- Machine service, maintenance and calibration
- Consistent color workflow using VersaWorks and: Adobe Photoshop, Adobe Illustrator, CorelDraw, FlexiSign, and SignLab.
- Roland VersWorks Overview / Features
File preparation and requirements, Media Profiles, Rendering Intents, Media Capabilities, and Advanced features.
- Printing / Laminating / Cutting
- Media properties, application, costing, tips

Workshop Requirements:
Roland printer or printer/cutter

Matt Zarben Helpful Hints



File Formats and Color Profiling

Do you have questions about vector vs. raster, printer color profiles, or other common production issues? Call Aksarben Sign & Graphic Supplies and talk to a tech.

Vector



100% EPS



Enlarged 600% prints at any resolution

Raster



100% 300 dpi



600% becomes 50 dpi

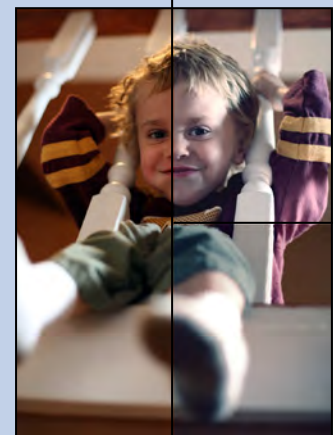

Correct Profile

Incorrect Profiles



Banner Finishing for Every Application...

We specialize in custom banners & signs



A Hem

1" fold over hem with no reinforcement. Designed for indoor or wall mounted installations.

B Rope

Three-ply twine is sewn into the top and bottom of the banner with standard 5' ties for easy securing.

C Webbing

Flat 1" woven polypropylene webbing is sewn into all four seams of the banner with 5' extensions for securing. A much stronger alternative to rope.

D D-Rings

Same as webbing style 'C' but with welded steel, zinc plated D-Rings in the corners for attaching bungee cords or rope.

E Webbing Reinforcement

Webbing sewn into all four seams provides an extra strong finish with no extensions.

F Reinforced Corners

Triangle of heavy-weight material is hemmed into banner corners to provide extra strength where it is most needed.

G Pole Pockets

A fold in the material is hemmed creating a 1^{3/4}" opening so the banner can be hung from a standard 1/2" conduit.

H Weld

Intense heat is used to "weld" a heavy-weight material onto the edges of the banner creating a more durable finish than the standard hem.



Custom Sewing
Proven



Customize...

Our banners are finished with brass grommets, color matched thread and double-lock stitching for appearance and strength that surpasses the competition.

We also do custom sign covers, break away banners, pennant banners and more!!!

Check out our website for the latest colors & prices available.

Ready Banners

130z Banner Blanks

Each Banner Blank is double-lock stitched, grommeted and individually boxed for easy stocking and resale. **White only.** Sizes not listed available on request.



	6'	8'	10'	12'
24"	\$12.75	\$16.75	\$20.75	\$24.80
36"	17.50	23.25	28.75	34.50
48"	24.25	31.99	39.95	47.75

PART # = RDYB+(Width)+(Length)

Custom Banners

Custom size banners, any size will do!
Call for pricing & ordering, or check our website.

100z Matte – Good for indoor:

- White
- Red
- Blue
- Black
- Yellow

130z Glossy – Our most popular choice:

- White
- Rich Red
- Navy
- Black
- Orange
- Marine Blue
- Forest Green
- Yellow
- Purple
- Kelly Green
- Sapphire Blue
- Beige
- New Maroon
- Royal Blue
- Ivory

160z Matte – Block Out banner material:

- White
- Red
- Mint Green
- Black
- Yellow
- Royal Blue

130z Ready Rolls



Banners in an instant!

Each Ready Roll is made of 130z material, double lock-stitched and grommeted every 2 feet. Just cut the length you need and finish the ends with hem tape for a custom sized banner whenever you need it.

Available in white only. (Also available without grommets.)

	2'	3'	4'
12 yd roll	\$43.80	\$50.50	\$69.75
24 yd roll	\$87.75	\$102.00	\$139.50

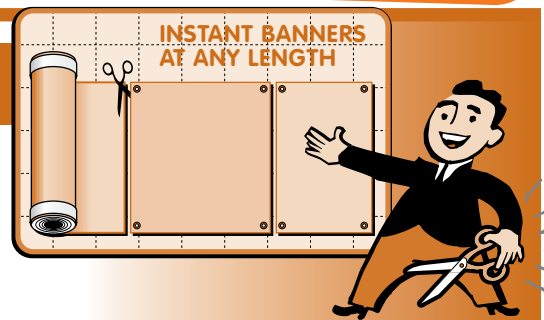

130z Welded Ready Rolls

Same as above, except intense heat is used to provide an extra strong finish to the material. Ungrommeted. **Available in white only.***

	2'	3'	4'
24 yd roll	\$165.00	\$182.50	\$227.50

*Allow for additional production time. Call for ordering information.

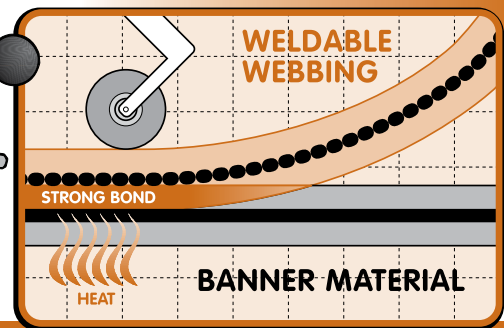
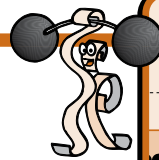

Banner Material

130z Show Off

We will cut to any length!
Call for Pricing.



160z Supreme Block Out

2-sided. Perfect for Outdoor

Supreme Block Out is an extremely durable material. Accepts vinyl lettering and screen printing, so it's great for outdoor use. Not recommended for enamel paints.

Available in White, Black, Red, Royal Blue, Yellow, and Mint Green.

16SBO-3625-(Color) 36" x 25 yd....	\$120.00
16SBO-7225-(Color) 72" x 25 yd.....	247.50

Great choice for durable banners in a wide range of colors. This high gloss material is ideal for screen printing and pressure sensitive vinyls.

40 Yard Roll

###+(Color)+Width 36" \$118.00... 61" \$210.00... 74" \$245.00

- Yellow
- Sapphire Blue
- Black
- Rich Red ★
- Forest Green ★
- Royal Blue ★
- New Maroon ★
- Marine Blue ★
- Navy ★
- Beige ☆
- Kelly Green ☆
- Ivory (36" only)
- Orange ☆
- Purple ☆

Available ★36" & 74", ☆36" & 61"

33 Yard Roll

###+(Color)+Width 36" \$86.00... 61" \$139.00... 73" \$161.00

- White

VIZUONCAL™ 4000 PVC Calendered Film

- Clear solvent acrylic adhesive
- Permanent
- Thermal print receptive
- 80# silicon coated kraft paper liner
- 3.0 mil thickness
- 3-5 year durability
- Great for mid-term applications
- Excellent cut/weed characteristics
- Indoor/Outdoor

4-year durability

Great Price Value. Great Product Quality.



★ 4770M Matte White ¹	4726 Brown ¹	4716 Wine Red ¹	4750 Blue ¹
★ 4770 White	★ 4739 Gold ¹	4764 Soft Pink ¹	4748 Mint ▲
4771 Light Grey ¹	4736 Beige ¹	4763 Pink ¹	4747 Turquoise ¹
4772 Dark Grey ¹	4732 Light Yellow ¹	4762 Lilac ▲	4746 Turquoise Blue ¹
4773 Dark Grey ▲	4731 Yellow ¹	4761 Lavender ▲	4743 Lime Green ¹
★ 4779 Silver ¹	4730 Dark Yellow ¹	4760 Violet ¹	4742 Light Green ▲
★ 4780M Matte Black	4721 Medium Orange ¹	4754 Sky Blue ▲	4741 Green ¹
★ 4780 Black	4720 Pure Orange ¹	4753 Cool Blue ¹	4740 Dark Green
4728 Light Brown ▲	4711 Tomato Red ¹	4752 Vivid Blue ¹	
4727 Medium Brown ▲	4710 Red	4751 Medium Blue	

★ 5-year durability
 ★ 3-year durability

VIZUONCAL 4000	BLK/WHT/CLR	COLOR	METALLIC	VIZUONCAL 4000	BLK/WHT/CLR	COLOR	METALLIC
15" x 50 yd punched	\$37.50	\$40.75	\$46.30	30" x 50 yd unpunched	\$74.75	\$77.95	\$92.65
15" x 10 yd punched	\$12.25	\$13.50	\$15.25	30" x 10 yd unpunched	\$24.50	\$25.45	\$30.25
24" x 50 yd unpunched	\$59.75	\$65.25	\$74.05	48" x 50 yd unpunched	\$119.50	\$130.50	\$148.25
24" x 10 yd unpunched	\$19.60	\$21.30	\$24.25				

Part # = 4000 + Color + Size

¹ Available in 15"/24" ONLY ▲ Discontinued Product

VIZUONCAL™ 6000 PVC Calendered Film

- Clear solvent acrylic adhesive
- Permanent
- Thermal print receptive
- 80# silicon coated kraft paper liner
- 2.6 mil thickness
- 5-7 year durability
- Good for slightly curved surfaces
- Short term vehicle applications
- Indoor/Outdoor

6-year durability

Always Excellent Results!



6700 Clear	6737 Ivory ¹	6766 Soft Pink ¹	6752 Blue
★ 6771M Matte White ¹	6736 Beige ¹	6765 Pink ¹	6751 Majestic Blue
★ 6770 White	6734 Light Yellow ¹	6763 Lilac ▲	6750 Dark Blue ¹
6772 Light Grey ¹	6733 Medium Yellow ¹	6762 Lavender ¹	6748 Mint ▲
6773 Medium Grey ¹	6732 Yellow ¹	6761 Violet ¹	6747 Turquoise ▲
6774 Grey ¹	6730 Dark Yellow ¹	6760 Purple ¹	6746 Turquoise Blue ▲
6775 Dark Grey ¹	6731 Saffron ¹	675A Light Blue ¹	6744 Yellow Green ¹
6776 Traffic Grey ¹	6720 Orange	6759 Sky Blue ¹	6742 Green ¹
★ 6779 Silver	6721 Pure Orange ¹	6758 Cool Blue ¹	6743 Medium Green ▲
★ 6781M Matte Black	6713 Tomato Red ¹	6757 Azure Blue ¹	6741 Forest Green ¹
★ 6780 Black	6711 Red	6756 Marina Blue ¹	6740 Dark Green ¹
6727 Medium Brown ▲	6710 Dark Red ¹	6755 Vivid Blue	
6726 Brown ¹	6716 Wine Red ¹	6754 Vibrant Blue ¹	
★ 6739 Gold ¹	6717 Burgundy	6753 Medium Blue	

★ 7-year durability
 ★ 5-year durability

HI-CAL 6000	BLK/WHT/CLR	COLOR	METALLIC	HI-CAL 6000	BLK/WHT/CLR	COLOR	METALLIC
15" x 50 yd punched	\$45.99	\$50.25	\$57.00	24" x 1 yd unpunched	\$4.50	\$4.90	\$5.65
15" x 10 yd punched	15.00	16.50	18.65	30" x 50 yd unpunched	91.95	100.60	114.15
15" x 1 yd punched	2.80	3.10	3.50	30" x 10 yd unpunched	30.00	32.90	37.30
24" x 50 yd unpunched	73.55	80.50	91.30	30" x 1 yd unpunched	5.60	6.00	6.95
24" x 10 yd unpunched	24.00	26.30	29.95	48" x 50 yd unpunched	149.00	160.95	182.95

¹ Available in 15"/24" ONLY ▲ Discontinued Product

Part # = 6000 + Color + Size

Need something you don't see in this catalog? Call today to find out how we can help.



7125 High Performance Cast Vinyl

- Permanent, durable graphics
- Vehicle graphics, striping, awnings, signs, banners
- Withstands tough conditions
- Pressure sensitive adhesive



7-year Scotchcal® ElectroCut™ Vinyl Flat with and without rivets; simple curves

010 White	089 Sandstone	263 Match Red	027 Indigo	357 Bermuda
090 Antique White	039 Tan	013 Tomato Red	197 Light Navy	196 Apple Green
011 Pearl Gray	049 Beige	063 Geranium	177 Shadow Blue	046 Kelly Green
031 Med. Gray	099 Fawn	053 Cardinal Red	037 Sapphire Blue	186 Bright Green
120 Satin Aluminum	130 Egg Shell	023 Deep Red	017 Vivid Blue	056 Dark Green
041 Dk. Gray	085 Vista Yellow	058 Burgundy	047 Intense Blue	066 Forest Green
022 Matte Black	015 Bright Yellow	193 Mauve	057 Olympic Blue	276 Bottle Green
012 Black	025 Sunflower	103 Magenta	077 Peacock	114 Transparent
019 Deep Mahogany	064 Apricot	273 Process Magenta	187 Wedgewood	020 Matte White
029 Russet Brown	105 Harvest Gold	088 Violet	086 Robin Egg	
139 Saddle Brown	024 Terra Cotta	098 Dk. Violet	176 Aqua	
131 Satin Gold	054 Light Orange	048 Purple	307 Dk. Aqua	
059 Putty	014 Bright Orange	038 Royal Purple	096 Teal	

Black, White, Clear	10 YARDS	50 YARDS	Colors	10 YARDS	50 YARDS	Part # = 7125 + Color + Size
15"	\$35.25	\$168.00	15"	\$41.25	\$195.25	* In-Stock Allow 3-5 days for delivery on certain colors & sizes
24"*	56.35	268.40	24"*	65.12	308.25	
30"	70.40	235.50	30"	81.40	385.00	
48"	112.64	536.80	48"	130.24	616.00	

2100/2200 High Performance Cast Vinyl

- Permanent adhesive
- Screen printable
- 85-90 gloss
- Thermal print receptive
- 78 pound liner
- 2 mil thickness



9-year Film For use with flat, flat with rivets, and corrugated surfaces

000 Clear	123 Dark Yellow	242 Med Burgundy	017 Sapphire Blue	170 Dk Forest Grn
200 Matte Clear	067 Primrose Yellow	159 Wineberry	005 Blue	142 Forest Green
002 Gloss White	182 Sunbeam Yellow	058 Dk Magenta	140 Intense Blue	024 Dark Green
049 Matte White	009 Orange	056 Hot Pink	214 Med. Blue	106 Medium Grn
102 Crystal White	133 Tangerine	124 Fiesta Pink	032 Azure Blue	126 Emerald
218 Parchment	248 Pumpkin	076 Magenta	018 Olympic Blue	061 Kelly Green
107 Almond	180 Terra Cotta	113 Salmon Pink	108 Peacock Blue	181 Willow Green
026 Oyster	169 Warm Red	135 Dk Orchard	225 Copenhagen Blue	069 Apple Green
068 Beige	014 Tomato Red	114 Raspberry	141 Shadow Blue	247 Vibrant Green
048 Camel	125 Wild Cardinal	063 Violet	139 Wedgewood Blue	227 Slate Grey
047 Buckskin	060 Bright Cardinal	253 Lilac	129 Medium Teal	122 Light Grey
179 Saddle	232 Fire Red	075 Lavender	130 Teal Blue	028 Dove Grey
178 Sand Pebble	134 Apple Red	074 Royal Purple	053 Dk. Bahama	050 Medium Grey
174 Taupe	234 Spectra Red	137 Deep Purple	071 Teal	110 Dark Slate
008 Brown	001 Red	168 Plum	246 Aquamarine	052 Dark Grey
059 Imitation Gold	042 Deep Cardinal	011 Dark Blue	117 Real Teal	040 Matte Black
231 Golden Yellow	250 Sundried Tomato	138 Lt Navy Blue	116 Dark Aqua	003 Gloss Black
006 Yellow	012 Burgundy	239 Majestic Blue	252 Sea	

Black, White, Clear	1 YARD	10 YARDS	50 YARDS	Colors	1 YARD	10 YARDS	50 YARDS	Part # = 2100 + Color + Size
15"	\$41.80	\$167.10		15"	\$45.92	\$183.65		Punched: Part # = 2200 + Color + Size
24"*	\$6.05	60.45	253.85	24"*	\$7.25	65.29	287.30	2220 Series Non-edge Stripped
30"	74.90	337.20		30"	90.60	362.40		000 Clear
48"	131.85	512.10		48"	146.85	470.28		002 White

3630 High Performance Translucent Film



- Transparent liner
- Wide color selection, many with Pantone simulations
- Liner resists moisture
- Great for multi-color registration
- Superior lay-flat characteristics
- Low surface gloss
- Uniform color in both reflected and transmitted light

6-year Scotchcal® ElectroCut™ 2 mil Cast Vinyl

020 White	141 Gold Nugget	083 Regal Red	036 Blue	126 Dk. Emerald
121 Silver	149 Light Beige	033 Red	137 European Blue	076 Holly Green
051 Silver Grey	005 Ivory	073 Dark Red	157 Sultan Blue	026 Green
071 Shadow Grey	015 Yellow	053 Cardinal Red	097 Bristol Blue	116 Bright Jade
061 Slate Grey	125 Golden Yellow	049 Burgundy	167 Bright Blue	146 Light Kelly
069 Duranodic	075 Marigold	128 Plum	127 Intense Blue	156 Vivid Green
022 Black	025 Sunflower	133 Raspberry	337 Process Blue	136 Lime
059 Dk. Brown	074 Kumquat	118 Intense Magenta	057 Olympic Blue	106 Brilliant Green
063 Rust Brown	084 Tangerine	078 Vivid Rose	147 Lt. European	115 Light Lemon
109 Light Rust	044 Orange	108 Pink	317 Evening Blue	
129 Bronze	043 Lt. Tomato	068 Rose Mauve	246 Teal Green	
131 Gold Metallic	143 Poppy Red	087 Royal Blue	236 Turquoise	

Black, White Clear

	1 YARD	10 YARDS	50 YARDS
15"	\$77.75\$380.77
24"* ..	\$13.98	124.40	609.25
30"	155.50761.53

Colors

	1 YARD	10 YARDS	50 YARDS
15"	\$81.44\$386.05
24"* ..	\$15.00	130.30	617.69
30"	173.45825.00

Part # = 3630 + Color + Size

* In-Stock
Allow 3-5 days for delivery
on certain colors & sizes

2100 Metallic 6-year Cast Film

- Permanent adhesive
- Thermal print receptive
- Screen printable
- 78 pound liner
- 85-90 gloss
- 2 mil thickness



041 Lt Gold	145 Lt Rose	165 Lavender	111 Bright Blue	192 Neptune Grn	186 Champagne
118 Bt Gold	039 Burgundy	164 Royal Purple	189 Periwinkle	193 Seafoam	194 Pewter
004 Gold	196 Garnet	146 Steel Blue	045 Blue	191 Aquamarine	120 Charcoal
020 Copper	119 Red	243 Grand Blue	190 Cool Water	167 Forest Grn	121 Dk Charcoal
187 Lt Sierra	254 Bijou Red	030 Dk Blue	127 Mist Blue	150 Dk Green	195 Onyx
161 Lt Brown	160 Dk Magenta	166 Electric Blue	256 Mtn. Mist	007 Silver	205 Aztec Gold
					255 Broadway Bronze

	1 YARD	10 YARDS	50 YARDS
15" Punched	\$57.16 \$228.64
24" Unpunched	\$9.99 86.21..... 344.83
30" Unpunched	109.39 439.50
48" Unpunched	175.77 703.00

Part # = 2100 + Color + Size

* In-Stock - Call for color availability.
Allow 3-5 days for delivery on certain colors & sizes.
24" Unpunched in stock. Other sizes available by special order.

3700 Ultra Metallic 5-year Cast Film

- Permanent adhesive
- Eye-catching reflectivity
- Designed for non-print
- 78 pound liner
- 3 mil thickness
- Punch or Unpunched



125 Wild Cardinal	075 Lavender	019 Cool Blue	004 Gold	003 Black	260 Desert Taupe
001 Red	030 Dark Blue	071 Teal	008 Brown	261 Diamond Dust	164 Amethyst
057 Raspberry	017 Sapphire	024 Dark Green	007 Silver	195 Onyx	

	1 YARD	10 YARDS	50 YARDS
15" Punched	\$77.50 \$325.50
24" Unpunched	..	\$13.85 118.40..... 532.70
30" Unpunched	146.60 644.96

Part # = 3700 + Color + Size

* In-Stock - Call for color availability.
Allow 3-5 days for delivery on certain colors & sizes.
24" Unpunched in stock. Other sizes available by special order.



Reflective Vinyl

- Permanent clear adhesive
- Screen printable
- Thermal print receptive
- 78 pound liner

- Cast vinyl
- 5.9 mil thickness

2409 Series

- 002 White
- 006 Yellow
- 009 Orange
- 001 Red
- 005 Blue
- 011 Green

2407 Series

- 002 White
- 004 Gold
- 006 Yellow
- 009 Orange
- 001 Red
- 060 Ruby
- 005 Blue
- 017 Sapphire
- 011 Green
- 003 Black
- 008 Brown

2409 Intermediate Utility Grade Reflective Film

5 Year Outdoor – designed for flat surfaces

	1 YARD	10 YARDS	50 YARDS
15"		\$93.72	\$374.88
24"	\$15.45	149.95	599.81
30"		187.44	749.76

2407 Premium Engineer Grade Reflective Film

7 Year Outdoor – for simple, curved surfaces

	1 YARD	5 YARD	10 YARDS	50 YARDS
15"		\$70.62	\$100.90	\$403.60
24"	16.65		161.44	645.76
30"			201.80	805.20

3500 Intermediate Etched Glass Vinyl

- Permanent clear adhesive
- Good on flat surfaces and simple curves
- 5 year outdoor durability

- Cast vinyl
- 2.0 mil thickness



3500-1515-007 15" x 50 yards \$287.00	<input type="checkbox"/>
3500-1503-007 15" x 10 yards 73.94	
3500-2415-007 24" x 50 yards 395.00	
3500-2403-007 24" x 10 yards 101.80	

220 Fluorescent Vinyls

These pigmented cast polyvinyl chloride films have a 6 month outdoor durability. Designed for safety and high visibility applications. Stocked in 24" wide rolls.

FL-220+(color code) .. \$11.25/yd ... 24" x 10 yds ... \$72.50
Other sizes available for special orders

Fluorescent Vinyl Series

- 001 Red
- 002 Green
- 003 Yellow
- 004 Orange
- 005 Pink
- 006 Blue

7725 Frosted Crystal



Designed to resemble sandblasted glass. Frosted crystal film has a clear permanent adhesive on a transparent synthetic release liner.

7725+(color code) \$17.00/yd ... 24" x 10 yds.. \$153.50
Other sizes available for special orders

Frosted Crystal Series

- 323 Frosted Rose
- 324 Frosted Crystal (stocked in 24")
- 326 Frosted Mint
- 327 Frosted Blue Mist
- 331 Frosted Gold



Don't See What You Want? **CALL US!**

SignAndGraphicSupplies.com



800-646-6064

NOTE: COLORS ARE APPROXIMATE DUE TO THE PRINTING PROCESS.

PRICES MAY CHANGE WITHOUT NOTICE.

Specialty Vinyl EFX Decorative Series



- Suited for general purpose signage applications.
- Both series of films resist most marring & staining.
- Cuts easily using computer plotter, steel rule or thermal die methods, shear or rotary blade cutters.
- Extruded 3 mil rigid PVC metallized film

- Both the Durable Series and the Decorative Series of films can be printed using vinyl screen print inks, thermal transfer systems, solvent-based inkjet printers and hot foil stamp devices.

1 3/8" Multi-Lens

Part # = D-ML + color + size

	Silver		Raspberry		Fluorescent Red
	Gold		Plum		Emerald Green
	Yellow		Royal Blue		Sky Blue
	Orange		Fluorescent Yellow		Galaxy
	Cherry Red				
24"					
5yd 10yd 50yd					
Silver					
\$42.45 61.50 257.00					
Color					
60.00 71.50 327.00					

Carbon Fiber

Part # = D-CF + color + size

	Galaxy		Silver	24"
5yd 10yd 50yd				
Galaxy				
\$50.60 72.00 291.45				
Silver				
39.45 56.60 235.70				

1/4" Mosaic

Part # = D-Mos + color + size

	Silver		Cherry Red		Sky Blue
	Gold		Purple		Flo Green
	Orange		Royal Blue		
24"					
5yd 10yd 50yd					
Silver					
\$40.00 55.50 237.00					
Color					
\$49.25 72.00 291.50					

Metal Flake

Part # = D-MF + color + size

	Silver		Cherry Red
	Gold		Raspberry
	Galaxy		Royal Blue
24"			
5yd 10yd 50yd			
Silver			
\$38.33 55.50 237.00			
Color			
49.25 55.50 237.00			

Diamond Plate

Part # = D-DP + size

	Silver	24"
5yd 10yd 50yd		
\$38.33 55.50 237.00		

Heavy Metal

Part # = D-HM + color + size

	FB-SLV Fine Brushed		SM-SLV Smooth Mirror
	FB-GLD Fine Brushed		SM-GLD Smooth Mirror
	FLRLF-SLV Florentine Leaf		
	FLRLF-GLD Florentine Leaf		
24"			
5yd 10yd 50yd			
Silver			
\$36.00 51.45 197.15			
Gold			
44.60 64.30 248.55			

Glowing

Part # D-SG + size

	Safe Glo	24"
5yd 10yd 50yd		
NA 220.30 895.75		

Outdoor EFX Durable Series Specialty Vinyl

- 3-5 years outdoor durable, 2.8mil. Stong bond.
- Printable with Eco-Solvent, Sovent, UV Screen and digital, and thermal transfers.
- Unique look demands attention!



	15"			24"			30"			48"			
	5yd	10yd	50yd	5yd	10yd	50yd	5yd	10yd	50yd	5yd	10yd	50yd	
	OD-SM-SLV Smooth Mirror Silver	\$53.75	70.95	310.75	\$81.00	107.00	467.15	\$101.25	133.85	586.95	\$162.00	214.15	934.25
	OD-SM-GLD Smooth Mirror Gold	62.50	82.50	366.95	95.50	126.50	557.15	-	-	-	191.00	252.95	1114.25
	OD-FB-SLV Fine Brushed Silver	63.15	83.10	366.95	96.00	127.45	557.15	120.00	159.25	696.45	192.00	254.75	1114.25
	OD-FB-GLD Fine Brushed Gold	73.75	97.50	431.25	113.50	149.50	655.75	-	-	-	227.00	299.00	1311.45
	OD-FLRLF-GLD Florentine Leaf Gold	73.75	97.50	431.25	113.50	149.50	655.75	-	-	-	-	-	-
	OD-HMLF-GLD Hammered Leaf Gold	73.75	97.50	431.25	113.50	149.50	655.75	-	-	-	-	-	-
	OD-LGE-GLD Large Engine Turn Gold	73.75	97.50	431.25	113.50	149.50	655.75	-	-	-	227.00	299.00	1311.45
	OD-SME-GLD Small Engine Turn Gold	73.75	97.50	431.25	113.50	149.50	655.75	-	-	-	-	-	-
	OD-BRTOV-SLV Bright Overall Silver	63.15	83.10	366.95	96.00	127.45	557.15	-	-	-	-	-	-
	OD-DMND-SLV Diamond Plate Silver	63.15	83.10	366.95	96.00	127.45	557.15	-	-	-	192.00	254.75	1114.25
	OD-CRBF-SLV Carbon Fiber Silver	63.15	83.10	366.95	96.00	127.45	557.15	-	-	-	192.00	254.75	1114.25
	OD-CRBF-BLK Carbon Fiber Black	73.75	97.50	431.25	113.50	149.50	655.75	-	-	-	-	-	-

Thermal Transfer



ThermoFlex Plus PLS



Digital Decoration Solutions: For use on cotton, cotton-poly, polyester, spandex, lycra, wool, linen and some athletic mesh garments. Will not adhere to nylon. Long Lasting, Non-Bleeding Formula.

5 YD ROLL	15" WIDTH	20" WIDTH
PLS+(color code)+(size)	\$39.25	\$52.33
9100 White	9340 Texas Orange	9577 Lilac
9150 Storm Grey	9426 Athletic Gold	9576 Columbia Blue
9236 Black	9450 Medium Yellow	9562 Sky Blue
9315 Flame Red	9472 Lemon Yellow	9540 Teal
9301 Red	9729 Vanilla Cream	9601 Aqua Green
9350 Maroon	9581 Lavender	9676 Forest Green
9312 Crimson	9513 Navy Blue	9669 Olive Drab
9310 Hot Pink	9584 Royal Purple	9633 Kelly Green
9305 Dusty Rose	9587 Wine	9625 Apple Green
9307 Medium Pink	9522 Royal Blue	9789 Chocolate
9335 Tangerine	9503 Mid Blue ▲	9465 Ochre
9333 Orange	9764 Sapphire	9460 Vegas Gold

ThermoFlex Plus Metallic Finish	15" WIDTH	20" WIDTH
PLS+(color code)+(width)	41.63	55.51
9843 Old Gold	9834 Antique Silver	

ThermoFlex Plus Neon Colors	15" WIDTH	20" WIDTH
PLS+(color code)+(width)	46.13	61.51
9910 Neon Pink	9930 Neon Orange	
9920 Neon Yellow	9940 Neon Green	

ThermoFlex Plus Metal Flake	15" WIDTH	20" WIDTH
PLS+(color code)+(width)	50.25	67.00
9858 Silver	9878 Red	9898 Green
9868 Gold	9888 Blue	9848 White

ThermoFlex Xtra TFX

No more outer liner. Self adhesive layer for easy weeding, greater detail and repositioning. Easier to work with. Even more durable than previous version. The best product for nylon, leather, and athletic meshes.

5 YD ROLL	15" WIDTH	*30" WIDTH
ThermoFlex Standard Colors		
TFX+(color code)+(width)	\$44.95	\$89.90
8100 White *	8426 Athletic Yellow *	8584 Royal Purple
8236 Black *	8513 Navy Blue	8576 Columbia Blue
8301 Red	8522 Royal Blue	8676 Forest Green
8310 Pink	8633 Kelly Green	8150 Storm Grey
8333 Orange *	8350 Maroon	
TFX+(color code)+(width)	\$49.50	n/a
9843 Old Gold	9834 Antique Silver	

DecoFlock DF

Provides the three-dimensional look and feel of soft velvet in an affordable, durable, and wash-safe transfer film. You can also adhere it atop our ThermoFlex® materials for added dynamic effect.

5 YD ROLL	15" WIDTH
DF+(color code)+(width)	\$59.75
6100 White	6426 Athletic Gold
6150 Grey	6472 Lemon Yellow
6236 Black	6513 Navy Blue
6301 Red	6522 Royal Blue
6333 Orange	6556 Vivid Blue
6307 Med Pink	6576 Columbia Blue
6341 Flamingo Pink ▲	6584 Royal Purple
6350 Maroon	6620 Bright Green
	6633 Kelly Green
	6729 Vanilla Cream
	6789 Brown
	6578 Turquoise
	6580 Lavender
	6317 Fire Red
	6355 Magenta

DecoFilm DecorativeMetallics

Adds the value of precious metals to your designs. You can also use these foils in conjunction with ThermoFlex® and DecoFlock™ films for brilliant accent or contrast.

5 YD ROLL	15" WIDTH	20" WIDTH
(color code)+(width).....	\$52.35	call
SS-5200 Super Silver	SC-5225 Super Copper	
SG-5250 Super Gold		
(color code)+(width).....	\$69.75*	\$69.75
BS-5205 Brilliant Silver	BG-5255 Brilliant Gold	

Ref-Lite RF

For nighttime visibility and brilliance in the spotlight films consist of very small glass beads embedded in a layer of polyester film to reflect almost all the light that shines on them.

5 YD ROLL	15" WIDTH	20" WIDTH
RF+(color code)+(width)	\$134.25*	\$134.25
Reflective glass bead retro-reflective to meet many safety standards. For use on cotton, cotton blend and nylon fabrics.		
9501 Safety Silver	8510 Fluorescent Red	8514-TF Orange
8503 White	8511 Fluor. Green	8515-NK Yellow
8506 Red ▲	8512 Green	8518 Black
8508 Fluor. Yellow	8507 Blue ▲	
8509 Fluor. Orange	8513 Cobalt Blue	

▲ Discontinued Product

* This item cut from 20" (15" + 5" drop)

GlitterFlex GF

Features multi-color holographic particles in a polyurethane matrix. Works on cotton, cotton/polyester blends and polyester/acrylic blends.

5 YD ROLL	15" WIDTH	20" WIDTH
GF +(color code)+(width).....	\$56.10*	\$56.10

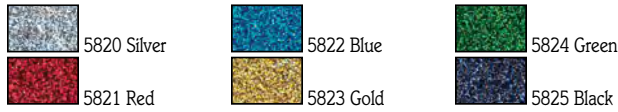

Deco-Sparkle DS

Holographic foil, for use on cotton/cotton blends fabrics and some mesh athletic uniforms. Always test first.

DS +(color code)+(width).....	\$58.95*	\$58.95
--------------------------------------	----------	---------

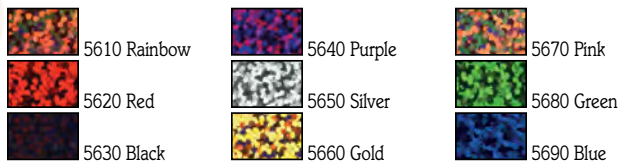

Wild Fashion Prints FP

Preprinted transfer materials that you can plotter cut in the shape of lettering, numbers or your custom design. Choose from Camouflage backgrounds, Cobra Skin and Leopard fur designs, Denim designs, Carbonium prints and a Techno pattern.

5 YD ROLL	15" WIDTH	20" WIDTH
FP +(color code)+(width).....	\$77.50*	\$77.50

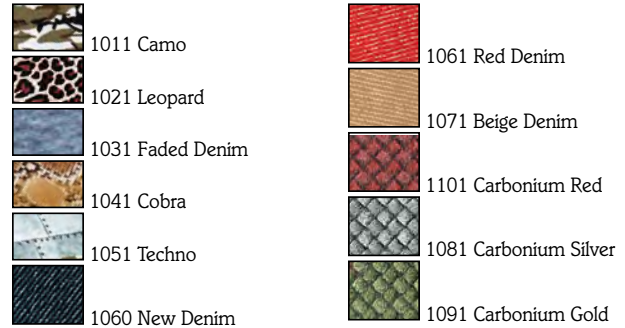

* This item cut from 20" (15" + 5" drop)

Digital Media for Textile Transfers



Thermal Transfer Digital Media

These semi-gloss white materials are designed for the Gerber Edge, Roland Color-Camm and other thermal transfer printers.

5 YARD LENGTHS	15"	20"	24"	30"
ColorPrint Standard				
CP2100	\$41.75	\$55.67	N/A	\$83.50
ColorPrint Nylon				
CPN2150	46.75	62.33	N/A	93.50
GlitterPrint				
GP2500	58.95	78.60	N/A	117.90

Desk Top Ink Jet

	8.5 x 11"	11 x 17"
Color Jet III, 10 pk Sheets	\$17.50	\$35.00
Color Jet III, 50 pk Sheets	75.00	150.00

Release Sheets

Teflon Release Sheets 18"x19".....	\$13.50 ea
Siliconized Release Sheets 11"x17".....	1.25 ea

Please call for pricing on any full roll lengths



ColorPrint for solvent/EcoSol ink jet printers

The best quality, brightest digital prints on the market!

	24" WIDTH x 5YD ROLL
CPS2160 White.....	\$77.40
CPSF2165 Frost.....	88.20
CPSS2168 Silver.....	92.10
Creates a metallic sheen to every color printed!	
CPLV2700 Leather.....	92.10
Great for tents, tarps and awnings. This is a gloss white polyurethane material designed for printing with solvent or eco-solvent ink jet printers to apply to low temperature substrates.	
	30" WIDTH x 5YD ROLL
CPS4625M Matte.....	\$55.50
CPS4626G Gloss.....	55.50

Roland

4mil Opaque Heat Transfer Material

This garment transfer material is an opaque white media designed to be print and cut for heat transfer to light or dark garments, either cotton or cotton blend. Finished transfers offer terrific color with good handling. Suitable pigment, dye and mild solvent inks.

PCM-HTM2-50-2424" x 50ft	\$1.50/ft ²	\$149.99
PCM-HTM2-50-5050" x 50ft	1.43/ft ²	297.75

3mil HeatSoft™ Polyester Transfer Mask

Polyester hot transfer mask for heat transfer appliqué material, designed to lift graphic from its backing liner sheet without removing ink of the printed surface, and intended to release shortly after pressing. Acts as a protective barrier from the heat press.

PGM-PTM-50-2424" x 50ft	\$0.56/ft ²	\$56.00
PGM-PTM-50-5050" x 50ft	0.54/ft ²	112.00

Heat Transfer Presses



The **Digital Knight** line of these commercial digital presses boast heavy steel welded frameworks built to hold up over many years of heavy use and stress. At the heart of these machines is a state-of-the-art digital microprocessor control and proprietary heat control circuit field tested beyond 10 million heating cycles.

Overall, the extremely accurate control and intuitively easy to use interface makes for a reject-free production environment.

JetPress Low Cost Presses with Professional Results

	price
JP12 JetPress 9x12 Swinger.....	\$279.00
JP14 JetPress 12x14 Swinger.....	495.00



Digital Knight Clamshell presses



These presses open much wider and lift up far away from the rear of the pad, staying away from user hands. The extra long & wide handle and smooth gas shock lift make for the easiest operation.

	price
DK3 Digital Knight Mug Press.....	\$750.00
DK7 Digital Knight Cap Press	595.00
DK7T Digital Knight Twin Cap Press	900.00
DK8 Digital Knight 6x8 Label Press	625.00
DK8T Digital Knight 6x8 Twin Label Press	950.00
DK16 Digital Knight 14x16 Clamshell.....	875.00
DK16-AUTO Auto Release Pop-Up Upgrade for DK16.....	+ 295.00
DK20 Digital Knight 16x20 Clamshell.....	1050.00
DK20-AUTO Auto Release Pop-Up Upgrade for DK20.....	+ 295.00
DK20S Digital Knight 16x20 Swinger	1350.00
DK25S Digital Knight 20x25 Jumbo Swing/std.....	2975.00



Digital Combo Multipurpose swing-away heat press

Professionally imprint T-Shirts, Caps, Plates, Tiles, Mugs, Memo Cubes, Miscellaneous Plastics, Woods, Metals, Fabrics and much more.

	price
DC16 Digital Combo 14x16	\$1195.00
DC16AP Digital Combo 14x16 Air Automatic	2250.00
DC-Twin Twin Shuttle Dual Table Attachment	575.00
DC-Cap Cap Attachment	275.00
DC-Mug 1/2 Mug Attachment.....	300.00
DC-Plate Plate Attachment (4.5" or 5.5")	225.00
DC-Cube Cube Attachment	200.00

Digital Knight Automatic Automated presses

	price
DC16AP Digital Combo 14x16 Air Automatic	\$2250.00
DK20SP Digital Knight 16x20 Air Automatic	2250.00
394-TS Air Op 16x20 Factory Twin Shuttle.....	6500.00
394-MTS ... Air Op 20x25 Factory Twin Shuttle.....	7795.00



DK Universal Stand

Heavy duty solid steel stand. Locking and pivoting wheels. Assembles in minutes. Keeps press mobile and easy to move. Makes space for tight locations & fully compatible with models: DK20S, DK20SP, DC16, DC16AP, DK20, DK16



DKA-STAND \$295.00

Teflon Sheets:

Non-stick Teflon sheets are the perfect cover sheet material for vinyl lettering and other applications.



TRM-SM1214 ... 12x14 ...	\$12.00
TRM-SM1416 ... 14x16	14.00
TRM-SM1620 ... 16x20	18.00
TRM-SM2025 ... 20x25	25.00

Teflon Wraps

Not just an accessory, a necessity. Allows garments and fabrics to slide on and off effortlessly & fast! Keeps rubber pad from pulling up, and easily wipes clean. For 16x20 and 14x16 presses.

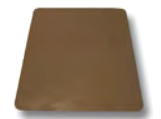

CTW-1416 14X16	\$30.00
CTW-1620 16X20	35.00

Sign Supplies Don't see it here? Ask Us!

CLEARSTAR COATINGS CORP. Application Fluids

Window Juice

Application Fluid for Glass

- For applying vinyl graphics to glass and windows
- Allows time to position your graphics
- Remove your transfer tape in under two minutes
- Works in extreme weather conditions



WINDOWJUICE1 qt \$9.50

Grafix Gone™

Adhesive Remover

- Softens adhesive residues within 90 seconds
- Will not harm most plastics or latex paint
- No extra cleanup after removing adhesive residue
- Smells good, works great

GRAFIXGONE 1qt \$11.00

Splash®

The standard for quality graphic application fluids

- Allows time to position graphics and remove air bubbles prior to adhesion
- Use on transfer tape to reduce tension
- Friendly, Safe, and Easy-to-Use
- Concentrated to mix 8 oz to one gallon of water



SPLASH8 oz \$11.25



Rapid Tac™

Cleaning and Positioning Fluid

- Wet application, makes it easier to apply vinyl without wrinkles or bubbles
 - Will not stain vinyl or banner materials
- RT-QT**.....Rapid Tac 32oz bottle w/sprayer..... \$11.14
RT-GAL.....Rapid Tac Gallon jug.....31.88

Rapid Tac II™

Cleaning and Positioning Fluid

- For use with other than premium vinyls
 - Speeds bonding for econo, intermediate, or metallized film
- RTII-QT**Rapid Tac II 32oz bottle w/sprayer..... \$16.56
RTII-GALRapid Tac II Gallon jug.....32.15

Rapid Prep™

Wax, Silicone and Grease Remover

- Removes surface build-ups
 - Use before Rapid Tac for best vinyl adhesion
- RP-QT**Rapid Prep 32oz bottle w/sprayer..... \$9.32
RP-GALRapid Prep Gallon jug.....24.57

Rapid Remover™

All-Purpose Adhesive Remover

- No oily residue, and silicon-free
 - Will not stain vinyl or banner materials
- RR-QT** Rapid Remover 32oz bottle w/sprayer ... \$16.56
RR-GAL ... Rapid Remover Gallon jug 48.04



Application Tools

3M Gold Squeegee

Lasts longer than ordinary squeegees.

3MGOLDSX..... \$3.25 ea.



MacTac Felt Squeegee

Will not scratch printed surfaces.

SQ-FELT..... \$2.49 ea.



LiftStick

Remove vinyl and vinyl adhesive.

GAPLSX1 (3/4" x 6")..... 99¢ ea



Rivet Brushes

Used for applying vinyl over rivets or irregular surfaces.

GAPRB1.5x1 (1.5") \$4.80 ea

GAPRB3x1 (3") 13.60 ea

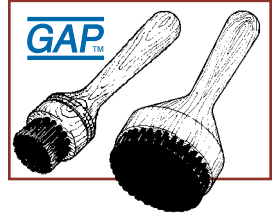

Speedball 4" Roller Applicator

Allows firm 90° downward pressure, without scratching the surface, no matter what angle you hold the handle.

SBX1 \$13.20



Grommets #2 Self-Piercing

Available in Brass, White, Nickel, and Black.
Prices for bag of 500 pairs.

GROM-SPB#2 (Brass).....\$49.99

GROM-SPB#2 (Black)64.99

GROM-SPN#2 (Nickel)54.99

GROM-SPW#2 (White) 79.99



Grommet Machine

Made of durable aluminum. Can be either bench-mounted or free standing. Use with our self-piercing #2 grommets.

GMPM5AL-W/DIE Machine + 1 Die Set \$329.99

GMPM5AL Machine only 183.00

DIE250PM5 Die Set 154.00



Measuring Tools



Sooper Edge Safety Rulers

Stainless steel cutting edge, with non-slip rubber gripper material on back. Purple anodized finish.

S-EDGE-E-28 (28")..... \$46.75

S-EDGE-E-52 (52")..... 91.29

S-EDGE-E-64 (64")..... 111.95

S-EDGE-E-76 (76")..... 120.70

S-EDGE-E-96 (96")..... 173.25

SpeedPress

Other SpeedPress Products Available
Call or check our website



Steel Edge Rhino

Super wide, super straight, and super safe ruler. Tough baked on powder coating, comfortable, no pinch safety guard, with new high tech super grip backing.

RR-28 (28") \$46.49

RR-40 (40") \$64.95

RR-52 (52") \$91.49

RR-64 (64") \$111.95

RR-76 (76") \$119.95

RR-100 (100") \$169.95



SignCraft
THE SIGN MAGAZINE
www.SignCraft.com

Available at
Aksarben



Measuring & Cutting Tools

KEENCUT

Excalibur 5000 Sheet Material Cutter



EXCALIBUR 5000



Standard inexpensive blades can be changed in seconds, with no tools

Designed to cut all the sheet materials used in the modern picture framing and visual communications industries, the Excalibur range cuts vertically, providing the ultimate in space saving convenience.

- Cuts sheet materials easily, cleanly and accurately
- Super-grip clamp holds thick materials at any angle
- Clear rule along the cut line for easy alignment
- Smooth sliding counterbalance for easy working

KE02 \$2,692.00

Cutter Bars

Simple no-nonsense cutter bars offer an ingenious cutting solution that is safe for both product and people.

- Blade depth adjustment
- Safely retracts the blade when not in use
- Standard utility blades will cut to a depth of 10mm
- Special long reach blades will cut 13mm (0.5")
- Patented linear bearings guaranteed for 20 years
- Full length silicon rubber grip strips provides protection for the most sensitive of surfaces
- Easily stored safely on the wall brackets provided.
- Optional surface mounted "Lift & hold mechanisms" so you can easily align large work single handed



Sabre	KS12	KS14
A - inches ✂	60"	100"
B - inches	66"	105.5"
Price	\$898.00	\$1,131.00

Technic Rotary Cutters

Excellent Value, Built to Last

Capable of cutting the thinnest of tissue and film to heavy cardboard, metals, plastics, fabrics and much more up to 3 metres (120") in length, there is a KeenCut rotary cutter just right for the job. Designed to give years of peak performance.

- All aluminium extruded and silver anodized base for strength and straightness
- 5 year full guarantee (excluding replacement cutting wheels).
- Excellent precision build quality
- Extensive range of special accessories
- Award winning customer service

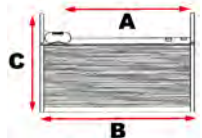

	Technic ARC60	KT10	KT12
A - inches ✂	60"	100"	100"
B - inches	70"	109.25"	109.25"
C - inches	21"	21"	21"
Price	\$677.00	\$874.00	\$874.00

THE AMAZING HOT ITEM

STICKY YARD™

DIGITAL MEASURING SYSTEM™

Can Save as JPEG

Place Sticky Yard™ on vehicle or window, take a digital photo, and download it to your computer. Open within the Sticky Yard™ Digital Measuring System™ v2.0 software, and click on each end of the Sticky Yard™ to scale the image. Once scaled the Sticky Yard™ Digital Measuring System™ software draws any line and giving you the measurements.

Includes one 36" adhesive and one 36" magnetic Sticky Yard™, plus software.

MEASURING MADE EASY!

SYE1009 Complete Measuring System	\$69.99
SYE 1012 Sticky Yard Adhesive (2 pk)	13.49
SYE 1013 Sticky Yard Magnetic (2 pk)	17.46

Measuring & Cutting Tools

Xtreme1® Cutting Mats

Cutting & Trimming has Never been Easier!

- 180 Gauge Self Seal Counter Top Mats
- Made From Virgin Seamless Polyethylene
- Cutting Blades Last Longer
- Sooper Tough Solvent Proof
- Marked surface for accurate cutting
- Other sizes available from 18x24" to 72x144"

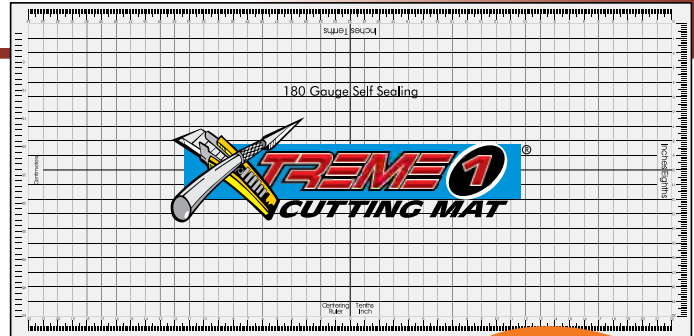

CM48P	48" x 96"	\$119.95
CM410	48" x 120"	129.95
CM412	48" x 144"	149.95

Need a different size? Call us!

Coro-Claw

- Hand-held flute cutter for corrugated PVC such as Coroplast®
- Ergonomically designed handle for effortless cutting
- Angle of the blade allows user to utilize the larger muscles of the back and shoulder
- Score with one prong, cut with two
- Most economical flute cutter on the market
- Every sign shop should have at least one



CC..... \$12.95



UltraMax™ Heavy Duty Cutter

- Anti-Slip Cushion Grip Handle
- Automatic Blade Lock
- Uses Heavy Duty Blades

LA-X..... Cutter.....\$8.50



Compass Cutter

- Cuts 3"-12" Diameter
- Cuts All Types of Materials
- Uses Heavy Duty Blades

CMP-2.....\$33.95



Heavy Duty Blades

Designed To Fit All OLFA "L" Series Handles

LBB-10B	10/pk.....	\$7.27
LBB-50B	50/pk.....	26.79

Rotary Blades

RB45-5	5/pk.....	\$25.55
---------------------	-----------	---------



HandSaver Knife

- High Quality Precision Knife
- HandSaver Cushion Grip
- Made For Professionals
- Uses Precision Art Blades

AK-4.....Precision Knife.....\$10.20



Deluxe Rotary Cutter

Great for Medium to Heavy Duty Projects (45mm Blade)

- Uses Rotary Blade

RTY-2DX.....\$21.65

Precision Art Knife

KB	25/pk.....	\$4.25
KB4-S	5/pk.....	3.40

Blade Disposal Can

Pocket sized can for quick & safe disposal

DC-3.....\$2.55



General Supplies



GXB-SCX1



GXB-601

GAP® Hobby Knife

Includes two #11 blades and one weeding tool

- GXB-SCX1** Hobby knife \$4.35
- GXB-7EX100** #11 blades, 100/pk..... 17.20
- GXB-601** Retractable knife 6.60
- GXBTK-1000** Graphix Tool Kit 21.40

Hook & Loop Tape

Adhesive-backed hook and loop fastener.

- TAPE-HL-KIT** 27yd x 1" rolls. **BEST VALUE** \$49.95
- TAPE-HOOK** 27yd x 1" roll 26.25
- TAPE-LOOP** 27yd x 1" roll 26.25

Stabilo Pencils **STABILO**

Water soluble marking pencils for use on banner materials. Available in blue and white.

- STABILO-WHT** \$12.99 dozen
- STABILO-BLUE** \$12.99 dozen

Tweezers

Pointed Tweezers, High quality stainless steel.

- TW-PX1** \$4.60

LEISTER Uniplan E Heat Welder

For efficient hot-air welding of industrial fabrics the Leister UNIPLAN E is ideal. A guide roller keeps the tool precisely on course. Its digital display shows set and actual values of temperature and welding speed. The heating is electronically controlled.

- Automatic start
- **High welding speed**
- Integrated lifting mechanism
- Small, light and handy
- Wrinkle-free welding

UNIPLAN-E \$3,995.00



Pantone Color Bridge

- Solid color and CMYK side-by-side comparisons
- Updated CMYK screen tint percentages
- sRGB and HTML values for solid colors
- Solid color and CMYK swatches both have bleed edges for easy color matching

PMS-CB \$119.00



SDI Dust Removal System

Start-up Kit includes: 1-Hand Roller (General Purpose Roller with Plastic Handle), 5-Cleaning Pads (9.5"x13" - 50 Sheets/Pad), 1-Cleaning Pad Holder.

- DRS-6GP-SK** 6" Kit, General Purpose Roller \$293.00
- DRS-12GP-SK** 12" Kit, General Purpose Roller 323.00

Cleaning Pad Replacements

- DRS-1** Cleaning Pads 9.5"x13" \$115.00/5pk
50 Sheets per pad, packed 5-pads per box
- DRS-4** Cleaning Pad Holder \$75.00



Roller Cartridge Replacements

- DRS-6R-(H, M, or GP)*** \$63.00
- DRS-12R-(H, M, or GP)*** \$85.00

***H** - High Tack (Blue) Use on rigid, thicker substrates such as, copper panels or glass. **M** - Medium Tack (Red) For Cleaning Artwork, Thin Materials, Flex Circuits, etc. **GP** - General Purpose (Light Blue) Use on most substrates with emphasis on cleaning thin or delicate substrates.



See page 12 for magnetic care instructions

Magnum flexible magnetic products are environmentally friendly. Our material is tested for non-toxicity and most of our products and packaging are recyclable.



Magnetic Sheeting

30mil recommended for Vehicle Magnets

- MAGL3050** 30Mil Gloss White..... 24"x50" \$150.00
- MAGL3025** 30Mil Gloss White..... 24"x25" 77.99
- MAGL3010** 30Mil Gloss White..... 24"x10" 39.00
- MAGMTW3050** 30Mil Matte White..... 24"x50" 121.60
- MAGMTW3025** 30Mil Matte White..... 24"x25" 70.50
- MAGMTW3010** 30Mil Matte White..... 24"x10" 32.00

20mil intermediate thickness for general usage

- MAGMTW2050** 20Mil Matte White..... 24"x50" \$110.99
- MAGMTW2025** 20Mil Matte White..... 24"x25" 56.25

15mil great for refrigerator, reminder and business card magnets

- MAGMTW1550** 15Mil Matte White..... 24"x50" \$97.94
- MAGMTW1525** 15Mil Matte White..... 24"x25" 52.00

Sign in a Tube

- 2, 30mil Matte White 12"x18" sheets
 - rounded corners
 - comes in a convenient tube
 - complete installation instructions
- MAGTUBE** \$11.99



Banner Ups **BANNER UPS** ADHESIVE GROMMET TABS

Quick, Inexpensive Alternative to Grommets

- For Digital Banners and Graphics of All Kinds
- Use Banner Ups PowerTabs to turn your image into a super strong outdoor banner - instantly
- Eliminate image damage caused by post print sewing
- No sewing, grommeting or special tools required
- Made of super strong polymer—stronger than grommets!
- Use with virtually any banner fabric, Corrugate, Foam Board or Paper

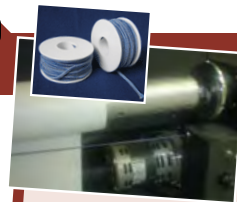

Eliminate Static, Improve Printing!

Wide Format StopStatic™ Kit

StopStatic™ is a trademark of Alpha Innovation, Inc.

Contains one 5 m roll of Static Elastic™ (36 ft/11 m extended), and 6 mounting magnets to attach to your machine. **The Static Elastic™ removes static from materials before they enter the print area, eliminating dust attraction and printing defects such as threading and fogging.**

WFSSK \$129.00/kit

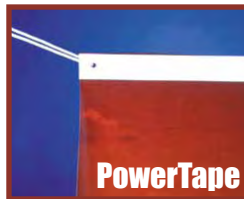
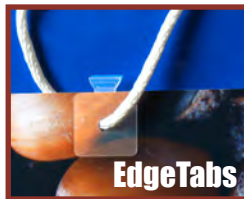
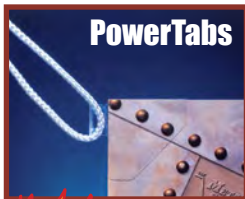

Banner Ups – Adhesive Banner Tabs

The original white Banner Ups

- BU-TAB-1** 51¢ ea
BU-TAB-100 \$26.00/100pk



- PT-WHT-MINI-1** 33¢ ea
PT-WHT-MINI-100 \$14.00/100pk
PT-CLR-MINI-1 51¢ ea
PT-CLR-MINI-100 \$31.00/100pk

EdgeTabs – Adhesive Grommet Tabs, Clear

The original white Banner Ups

- E-TAB-1** 52¢ ea
E-TAB-100 \$32.00/100pk

PowerTabs – Adhesive Grommet Tabs, White or Crystal Clear

- PI-WHT-1** 51¢ ea
PI-WHT-100 \$26.00/100pk
PI-CLR-1 82¢ ea
PI-CLR-100 \$48.00/100pk

PowerClips – Reusable & Strong
Quick and easy to install! The harder they pull - the harder they grip. No need to cut holes

- PC-WHT-MINI-1** \$1.30 ea
PC-WHT-MINI-100 \$65.00/100pk
PC-WHT-LRG-1 \$1.70 ea
PC-WHT-LRG-100 \$85.00/100pk

PowerTape – Reinforce Hems

- P-TAPE 1 1/2" x 36yd**..... \$23.00/rl

PoleTape – Adhesive for Pole Pocket Banners and Splicing Media

POLETAPE 1" x 200ft..... \$79.00/rl

PowerPunch

Cuts cleanly through tabs, tape and banner media! New design is heavy duty, yet light weight. Perfectly sized for PowerTabs®. Replaceable punch for long life.

POWERPUNCH \$44.00

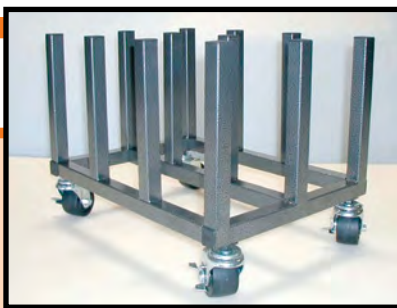

Media Racks & Baskets



- MR16** (16 spindles) \$227.70
MR12 (12 spindles) 209.00

Vinyl Floor Rack

Holds 44 Rolls of Vinyl
No Weld Construction
Easy to Assemble
74" x 32" x 18 1/2"
GFR-44 \$255.00

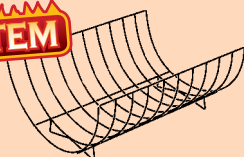
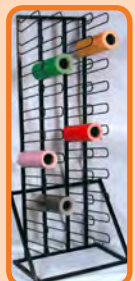

- GFR-1623** (16 spindles) \$198.00
GFR-1000 (portable handle) 34.50
GMS-1000 Media Saver 68.20
30"W x 24"D





Transfer Tapes

Release Liner Adhesion (RLA™) Technology

- Improved release liners, maintains adhesion levels to graphics.
- Special release liner prevents lifting, tunneling and edge curling.

4075 RLA®



Most popular application tape available standard weight saturated paper with high tack adhesive for clean pick up and transfer of small and medium sized lettering and graphics.

100yd roll, 4-4.5mil, \$2.44/in

R4075RLA-12.....	12"	\$29.28
R4075RLA-15.....	15"	36.60
R4075RLA-24.....	24"	58.56
R4075RLA-30.....	30"	73.20
R4075RLA-48.....	48"	117.12

4076 RLA®



Standard grade paper with a slightly higher tack. Excellent for hard-to-transfer vinyls, small and medium-size letters, specialty vinyls and thermal die cuts.

100yd roll, 4-4.5mil, \$2.44/in

R4076RLA-12.....	12"	\$29.28
R4076RLA-15.....	15"	36.60
R4076RLA-24.....	24"	58.56
R4076RLA-30.....	30"	73.20
R4076RLA-48.....	48"	117.12

4775 RLA®



Heavy weight paper with high tack adhesive for consistent transfer of small and medium size lettering and graphics. Exceptional resistance to abrasion and moisture. Aids long term storage, transport, and handling, Conforms to uneven surfaces

100yd roll, 5-5.5mil, \$3.06/in

R4775RLA-24.....	24"	\$73.44
R4775RLA-30.....	30"	91.80
R4775RLA-48.....	48"	146.88

4761 RLA®



Medium tack level for large graphics. Premask for printed vinyl graphics. Clean transfer with wet application. All purpose transfer & prespace tape.

R4761RLA : (100yd roll, 3.9-4.3mil)

R4761RLA-24.....	24"	\$74.88
R4761RLA-30.....	30"	93.60
R4761RLA-48.....	48"	149.76

ApliTape™ 4075 ApliTAPE.

Standard weight paper economically priced, having all of the same features of the popular Conform Series, but without the RLA; Release Liner Adhesive additive.

100yd roll, 4-4.5mil, \$2.29/in

R4075-24.....	24"	\$54.96
R4075-30.....	30"	68.70
R4075-48.....	48"	109.92

DigiMask™ DigiMask.

With RLA®. Standard weight paper with an ultra-low tack solventless adhesive designed specially for surface protection and application of wide format digital graphics.

100yd roll, 3.5-4mil, \$2.29/in

RDIGI-24.....	24"	\$54.96
RDIGI-30.....	30"	68.80
RDIGI-48.....	48"	107.25

AT-60 ClearChoice™

An economical, ultra clear application film. Features a slightly tackier adhesive designed for clean pick up of all brands of cast or calendered vinyl. Exceptional clarity to aid precise registration of multicolored overlays.

100yd roll, 3.5-4mil, \$2.39/in



RAT60-24.....	24"	\$57.36
RAT60-48.....	48"	114.72

AT-75 ClearChoice™

AT-75 combines two different film tapes; the EZ-Tear AT42 face stock with the tackier version of the AT60 adhesive system making it a very user friendly product. The Air-egress micro-tunnels in the adhesive allow for bubble free lamination of the tape to vinyl graphics.

100yd roll, 6.4mil, \$2.59/in



RAT75-24.....	24"	\$62.16
RAT75-48.....	48"	124.32



Custom Tape Cut to YOUR widths at no extra charge!

Don't make do with factory set tape widths when you can get custom sizing at Aksarben Sign & Graphic Supplies. Just tell us the width you need and we'll cut to your specifications.



Hem Banners without sewing



Step 1

Apply tape on the banner's edge, and expose adhesive.



Step 2

Fold the edge over and squeegee down to secure.

Hem Tapes

- Hem without sewing (see above)
- Matt Zarben Approved

TAPEHEM-1.....	1" x 36 yd	\$10.49
TAPEHEM-1.5.....	1.5" x 36 yd.....	15.75
TAPEHEM-2.....	2" x 36 yd	20.98



Ultra High Bond (UHB) Tape

36 yard roll, 2-sided, extremely high tack tape.

Structural grade tape is comprised of solid acrylic polymer, coated on both sides with a high-tack acrylic adhesive, and white polyethylene release liner. Provides a superior, permanent bond between a wide variety of substrates. Solid acrylic core gives tape superior strength; it can be easily applied and cleanly cut, yet is flexible, moldable, compressible & conformable to intricate shapes. Tape will bond to most surfaces, but thorough evaluation is recommended when bonding low energy surface material such as PVC, ABS, PE, PP. Not recommended for bonding Teflon™, Tedlar™, Silicone, or EPDM.



DC-UHB45-3/4	3/4" x 36 yd.....	\$49.95
DC-UHB45-1	1" x 36 yd	54.95

Foam Tape



1/16" thick, Double Coated Polyethylene Foam Tapes.

A high density cross linked polyethylene foam tape coated on both sides with a high performance rubber-based adhesive. Excellent quick-stick sealing with high shear properties. Good resistance to humidity, mild acids, oil and grease. Excellent conformability and compressibility. Adheres well to textured and irregular surfaces. Can be easily die-cut.

DC-PEF06R-1/2.....	1/2" x 36 yd.....	\$18.95
DC-PEF06R-3/4.....	3/4" x 36 yd.....	24.95
DC-PEF06R-1	1" x 36 yd	29.95

PowerTape

Hem Reinforcing Tape

P-TAPE 1 1/2" x 36yd..... \$23.00/rl

QUICK TRANSFERS

Tape-Owner

- Inexpensive time-saving solution
- Bubble-free pre-mask application!
- Matt Zarben Approved
- Cores not included

TAPE-OWNER..... \$25.00



Green Mask

Premium Safe Tack Masking Tape.

For use on regular, semi-delicate and delicate surfaces. Recommended where the tape needs to be removed up to seven days after application. For masking application where UV resistance is required. Designed to resist most paint and lacquer. Adhesion remains stable over time. Removes cleanly even after long application. Paper provides excellent conformability and tear resistance. Medium quick stick, light adhesion.

TAPEMASK-1.....	24mm (~1") x 60 yd	\$3.99
TAPEMASK-2.....	48mm (~2") x 60 yd	7.98

Strapping Tape

General Purpose Filament Tape.

To hold pharmacy cabinet frame together. For reinforcing baker's trays. As a bond breaker in the concrete industry. Palletizing of boxes. Strapping rods, molding, tubes plywood without danger of scratching, staining or damaging. Reinforcing boxes, protecting contents from pilferage. Benefits: Strong, waterproof, high tack, excellent shear, little stretch.

TAPESTRAP-1..... 24mm (~1") x 60 yd..... \$2.25

PoleTape

Adhesive for Pole Pocket Banners and Splicing Media

POLETAPE 1"x200ft..... \$79.00/rl



Plasticade Products

A-frame Style

**PLASTICADE®
PRODUCTS**

Marquee

HOT ITEM

A perfect solution for your sign needs. The Marquee Sign Stand comes in standard white, or when colors are required for the desired affect, it also comes in black, blue, green, and red.

- Overall size 26" w x 41" h
- Sign display area 24.5" x 36.125"
- Easy open handle makes lifting and setup easy
- Weight 16 lbs., can be ballasted with 5 lbs. of sand per side (total of 18 lbs)



Marquee

Minicade

Signacade

Colors Panel Size 1-5 6+

Marquee: AFMQSGN-(color) 24.25" x 36.12" ... \$65.50 \$62.50

Signicade, Squarecade & Minicade

- Easy open handle makes lifting and setup easy, and can be ballasted.
- Same rugged construction as the Marquee.

Signicade: AFSIGN-(color) 24" x 36" \$62.50 \$59.50
Squarecade: AFSQUARE-(color) 24" x 24" 55.50 50.50
Minicade: AFMINI-(color) 12" x 24" 40.50 38.50

Don't forget the Well Nuts WELLNUTS.....20-pack.....\$12.50

Signicade® Letter Kit

Transform any Signicade® into a Changeable Message Sign Stand. Available with Black Letters or White Panels or White on Black.

- 2 (24 X 36") white Plastic Panels with Letter Tracks attached.
- Over 300 pcs. 4" Black/White letters and 4" Red numbers.
- 22 pcs. 8-inch Numbers in Red.
- 2 large Header Cards "SALE" & "SPECIAL"
- Box for letter storage, all hardware & easy Instructions.

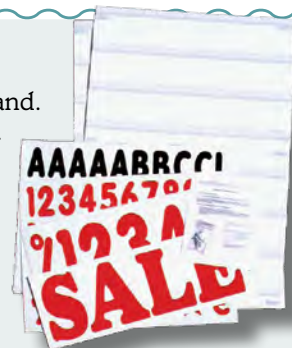

AF8410-MK-WHT\$95.00
AF8410-MK-BLK.....105.00

Wind Resistant Signage

Easily ballast signs with sand or water. (Holds up to 10 pounds internally.)



FREE Funnel

How to install a changeable sign face



1 Drill 1/2" holes into the face of the A-frame.



2 Insert Well Nuts and position the sign face blank.



3 A few quick turns of the screwdriver and you're done!

Well nuts? Thanks for asking!!!



Rubber piece will expand as screw tightens

QuikSign

PLASTICADE PRODUCTS

Change a-frames in seconds w/no extra hardware. Once installed, signs stay securely locked in place.

- High density polyethylene assures no rust, splinters, discoloration or maintenance
- Attractive, light weight, durable and quite the bargain
- Molded-in handle assures easy portability
- Molded-in regress helps protect sign faces
- Display two signs per unit
- Easily stacked



PUSH UP
SLIDE DOWN



Height: 30.5", Width: 26", Weight: 6.5 lbs. **QuikSign**

	Panel size	1-5	6+
AFQUICKSIGN	24"w X 18"h	\$36.95	\$33.95

SimpoSign

One A-Frame, Many Signs

- Molded-in stacking lugs nest into each other when units are stacked which prevents sliding
- Molded-in regress helps protect sign faces
- Molded-in handle assures easy portability
- All plastic - no rust, splinters, discoloration or maintenance
- Attractive, light weight, durable and inexpensive
- No bolts, latches, added parts or special treatment
- Can use all Sign blanks including corrugate and aluminum
- Accommodates standard dimension for all retail signs



SimpoSign

Height: 34", Width: 23", Weight: 8 lbs.

Change signs in seconds!



Slides in easily...



..stays securely in!

Fits standard retail signs 22" x 28"

	Panel size	1-5	6+
AFSIMPOSGN	22"w X 28"h	\$46.50	\$42.50
AFSIMPOII	22"w X 28"h	\$46.50	\$42.50

Sturdy built-in stabilizing brace for sandbagging

Comes with strong brace that clicks into storage

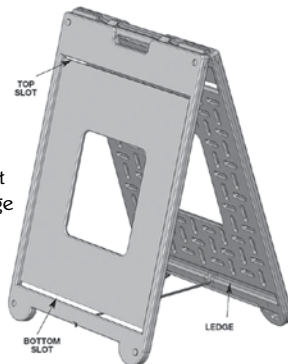

SimpoSign II

Height: 36", Width: 24", Weight: 8.2 lbs.

Molded-in Stacking Lugs

Each lug nests into each other when units are stacked which prevents sliding. Nice.

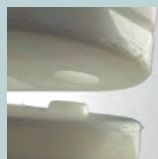

WindSign

Stands Up in Strong Winds

- Springs connect the frame to the base allowing sign to resist winds and return to upright position.
- "Quick change" feature enables sign blanks to be changed in seconds and stay securely in place.
- Two clips included with every WindSign.
- Sand or water fillable plastic base with factory installed wheels. Free funnel included.
- Molded-in tie down hole allows for chaining or wiring the base, deterring theft.
- Molded-in handle and factory installed wheels assure easy mobility.
- Attractive plastic frame design eliminates torn miters and jammed latches. Won't rust or splinter.
- Two-sided (holds two signs per frame). Can accommodate coroplast, aluminum, acrylic, or any foamboard.

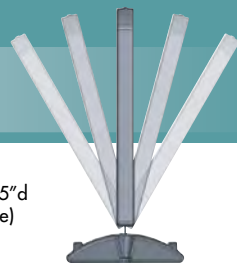

WindSign II
40.75" h x 26" w x 2.5" d
(48" h x 26" w on base)
weight: 17 lbs.

WindSign
32.75" h x 24" w x 2.5" d
(40" h x 26" w on base)
weight: 16 lbs.

Assembles in less than 5 min.
PUSH UP
SLIDE DOWN

Base: 4.5" h x 26" w x 18" d
weight: 4.3 lbs.
(90 lbs. filled with sand)
(45 lbs. filled with water)

Cat#	Description/color	Panel Size	Qty 1-5	Qty 6+
AFWIND-22x28	Wind Sign/Grey	22" w X 28" h	\$79.00	\$71.00
AFWIND-24x36	Wind Sign II/Grey	24" w X 36" h	89.00	81.00

SidewalkSign

- Available in black, granite, and white. 24" x 36" sign blanks can be changed in seconds.
- Ballastable outrigger feet slide into place, no tools required.
- Small footprint and classic design, with molded in handle and tie down.



PLASTICADE[®] PRODUCTS

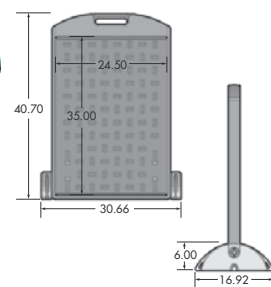

Cat#	Description/color	Size	Qty 1-5	Qty 6+
AFSIDEWLK/WHT ..	Sidewalk Sign/White.....	24" w X 36" h	\$62.50	\$54.00
AFSIDEWLK/BLK	Sidewalk Sign/Black	24" w X 36" h	62.50	54.00

RealiCade & T-Cade

PLASTICADE[®] PRODUCTS

Strong & Lightweight Plastic Yard Signs

- Plastic yard signs that replace the heavy metal frames used in real estate.
- Strong, durable & lightweight. Made of high-grade engineered polyethylene.
- Easy to install using foot-push mounts or hammer knobs (for hard soil).

Cat#	Description/color	Size	Qty 1-5	Qty 6+
SFRC-170/WHT ...	RealiCade - White.....	24" w X 18" h	\$15.80 ...	\$13.95
SFRC-171/BLK	RealiCade - Black	24" w X 18" h	14.80	12.95
SFTC-181/BLK	T-Cade - Black.....	17.25" w X 42.5" h	5.80	5.00

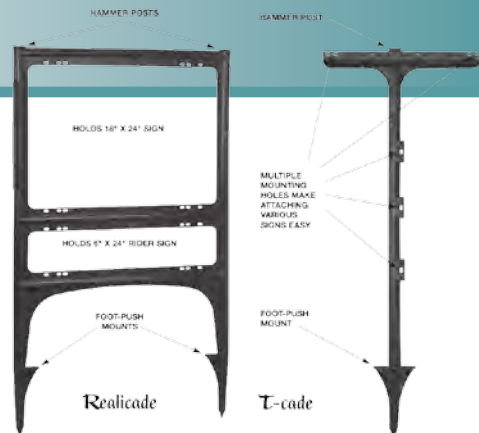

Message Kit

PLASTICADE PRODUCTS

- Available in black or white for Marquee Sign, Signicade, Sidewalk Sign, Select Wind Signs, & Simpo Sign II (wht only)
- Each kit contains 2 coroplast boards (wht or blk) with tracks affixed, complete number & letter set, storage box with tabs & 12 screws to affix to sign frame. **Sign frames sold separately.**

AF8430-MK-WHT	28" x 40" White	\$111.90
AF8410-MK-WHT	24" x 36" White	95.00
AF8420-MK-BLK	24" x 36" Black	105.00
AF8400-MK-WHT	22" x 28" White	85.99



Letter storage box



PUSH UP
SLIDE DOWN

Replacement Kit

Replacement 3" Letter Set for 22" x 28" White Message Board. Letters are black on white, red on white numbers. Open House, Special, Sale, & Hiring on large headers.*

AF-8400-RL	3" White Letters.....	\$55.00
-------------------------	-----------------------	---------

Replacement 4" Letter Set for 24" x 36" White Message Board. Letters are black on white, with red on white numbers. Set includes letters and numbers only.*

AF-8410-RL	4" White Letters.....	\$46.45
-------------------------	-----------------------	---------

*Does not include box or index tabs.

Fdc Dry Erase Vinyl

GRAPHIC FILMS, INC.

Calendered film

Specially formulated for interior use. Can be written on repeatedly and wiped clean with tissue or dry erase cleaning fluid.

DRYERASE24	White Vinyl 24"	\$10.00/yd
DRYERASE2410 ...	White Vinyl 24"x10y.....	75.00/rl

Marker Board

- Available in black or white for Marquee Sign, Signicade, Sidewalk Sign, All Wind Signs, & Simpo Sign II
- Each kit contains 2 coroplast boards with 5 neon makers & 12 screws to attach boards to the sign frames
- Markers do not rub off or wash off in the rain. **Sign frames sold separately.**

AF8540-MB-WHT ...	28" x 40" White.....	\$52.90
AF8520-MB-WHT ...	24" x 36" White.....	35.50
AF8530-MB-BLK	24" x 36" Black.....	35.50
AF8500-MB-WHT ...	22" x 28" White.....	32.00
AF8510-MB-BLK	22" x 28" Black.....	32.00



For White Board: Black, orange, green, blue & red



For Black Board: White, orange, green, pink & yellow

NeoPlex Markers

- Vivid, bright fluorescent markers! Write or draw on nearly anything!
- Use them for sign markers, glass markers, window markers, almost anything you can imagine! Make your sign making jobs EASY!

NOT RECOMMENDED FOR DO-IT-YOURSELF "PAINTED ON" CHALK SURFACES!

NM-1	Chisel tip	\$3.99/ea
NM-2	Wide tip	6.99/ea



Displays

Displays

Frames & Stakes

VER-MAC Industries, Inc.

Coro-Stakes (For Corrugated Plastic)

Economical yard sign solution: 9 gauge top wire, zinc plated finish, for 4mm corrugate

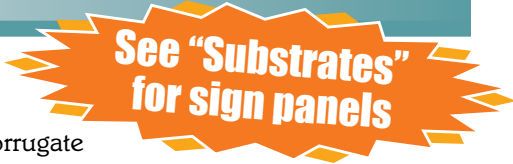

Stringer Coro-Stake

- Economical Coro-Stake
- Completely 9 ga. construction
- Taller Than Normal Stakes!

SF-VM100 (each)\$1.49
SF-VM100-50 (50 qty, 81¢ ea)....40.50

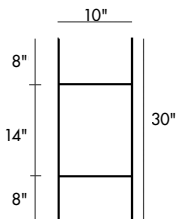

Standard Coro-Stake

- 1/4" Rod Base

SF-33STD (each)\$3.40
SF-33STD-25 (25 qty, 2.90 ea)....72.50

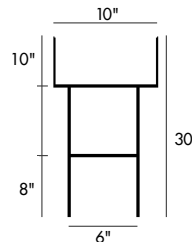

E-Z Coro-Stake

- 3/16" Rod Base

SF-30EZ (each)\$2.69
SF-30EZ-25 (25 qty, 2.09 ea).....52.25

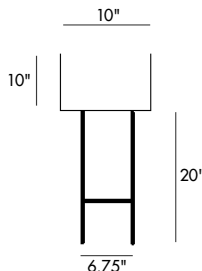

Premier Coro-Stake

- 5/16" Rod Base

SF-PREM (each)\$4.80
SF-PREM-25 (25 qty, 4.40 ea) ..110.00

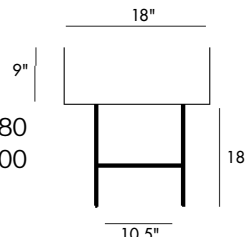

Angle Iron Frames



Slide-In or Bolt In to Place!

Hybrid Bolt-In and Slide-In COMBO Frames

- Sturdy 3/4" angle iron
- Rounded corners
- Black powder coat finish

SF-18x24-HYSI ... \$13.00 ea (6/case, 11.50 ea)..\$69.00
SF-24x36-HYSI 16.25 ea (6/case, 14.50 ea)....87.00

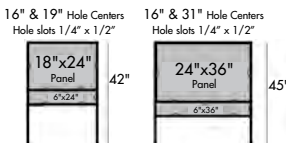

Spring Clips for Sign Frames

SF-SPRING-CLIP..... 35¢

Bolts In Secure! Bolt-In Angle Frames

- Stays secure in wind
- Strong construction
- Black powder coat finish

SF-20x28-HR..... \$16.15 ea (6/case, 15.00 ea)...\$90.00

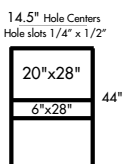

Round Rod Frames



R-Style Frames

- 1/2" Round Rod
- "Classic" frame design
- 3/4" flat crossbars
- Pre-punched slots
- Black powder coat finish

SFRR-18x24 \$13.75 ea (6/case, 12.50 ea)...\$75.00
SFRR-20x28 14.85 ea (6/case, 13.67 ea)....82.00

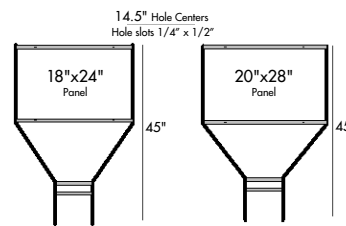

Sign Stake

- Versatile Sign Solution
- 3/4" angle iron stakes
- 42" height
- 1/8 x 3/4" Flat Top Strip
- Pre-punched slots
- Black powder coat finish

SF42-TBAR \$6.25 ea (12/case, 5.42 ea).... \$65.00

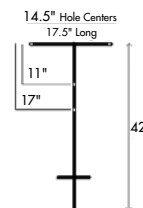



SIGN FRAME AND STAKE

America's Looking For The **GREEN** Alternative

USA Sign Frame and Stake offers innovative, high-quality and environmentally-responsible designs that are attractive and functional products at competitive prices. Engineered to be sturdy, durable, inexpensive, and light-weight, each design offers integrated features that a welded-metal version simply can't match.



USA Spider Stake

- Corrugated Plastic Step Stake. Replacement flimsy "H" wire stake.
- Fresh contemporary appearance
- Penetrates hard ground much easier than a thin H-wire.

USA-SS01 each.....79¢
USA-SS01-50 50pc/55¢ ea..... \$27.50

USA Car Window Clip

- Lightweight and very durable.
- Slides on most car or truck windows.
- Great for car dealer's & Real Estate agents to draw attention.

USA-DC01 each.....\$3.10
USA-DC01-30.....30pc/2.70 ea81.00



Large USA A-Frame

- Use a variety of substrates, 4-6 mm.
- Bungee-style center support is extremely flexible.
- Simple and cost competitive.
- Accommodates sizes from 18" x 24" to 36" x 60" or more.

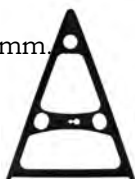

USA-AF01 each.....\$22.85
USA-AF01-3.....3pc/21.30 ea 63.90

Standard A-Frame

- Displays standard 18" x 24" or 24" x 24" signs or wider (up to 36").
- Bungee-cord elastic strap for exceptionally easy setup.
- Economical.



USA-A1AF01..... each.....\$8.50
USA-A1AF01-12 .12pc/7.95 ea 95.40

USA Hot-Dog Stand

- POP table top stand for corrugated plastic.
- Designed for indoor use.
- Perfect for displaying counter top courtesy signage.



USA-HDS01 each.....95¢
USA-HDS01-50 50pc/80¢ ea.....40.00

Mounting Hardware



Sooper Sign Hanger

Aluminum Bracket with white finish. Bolts through sign face for a clean finished look. Available in 1/2" and 3/4".



PART#	SIZE	PRICE
SHA1050	1/2" Hanger	\$2.25
SHA2075	3/4" Hanger	2.25

LinKlip & LinKlamp

New sign bracket system for attaching signs to chain link fencing, square sign post or U-channel post. Use the LinKlip & the LinKlamp and take the hassle out of hanging banners on chain link fencing.



SLK3000	LinKlip-Chainlink fence mount w/bolt	\$1.30
SLKLAMP	LinKlamp-Banner Plate.....	3.80

U Brackets

Powder coated brackets for sign panels



IOI-CB-8025	Center Bracket 1/4"	\$2.80
IOI-UBA-4025	Sooper U Bracket 1/4"	3.95
IOI-UBA-5050	Sooper U Bracket 1/2"	3.95

Boulevard Brackets Kits

Fiberglass Mounting System for Pole Signage

- Advanced design system withstands the elements
- Fiberglass arms will flex in wind, reducing banner wear
- Rust-free cast aluminum base

Kit Includes:

2 poles, 2 brackets, 2 end caps, 2 plastic ties, 2 pins, 2 lock rings, and 4 40" stainless steel bands

AS-30, Single-set 30" kit..... \$52.28



Displays

Displays



SignComp™ Post & Panel Systems

NUDO PRODUCTS, INC.
Poly-Metal™
 2-sided Aluminum Signage
 Companion Substrate Page 72

- Powder coated gloss white or black.
- 48" slot to fit up to a 48" high, 1/8" or 3mm panel.
- One adjustable, 48" aluminum Post Filler to accommodate a less than 48" high panel.
- One 1/8" aluminum post cap with cap screws.
- One 96" aluminum, adjustable Panel Trim for 3mm hollow core panel.
- Two 6" Locking Strips.

RTS11015-8 \$105.00
 96" Ready to ship Square Post – black or white
RTS11017-8 97.00
 96" Ready to ship Round Post – black/white

HOT ITEM

Pre-Painted Post & Panel Kits

- Reveal can be set in the zero, 3/8" or 3/4" position.
 - Mill finish or pre-painted Dark Bronze finish.
 - Simple to assemble.
- Additional sizes available
 NOTE: Face material not included

Series 2

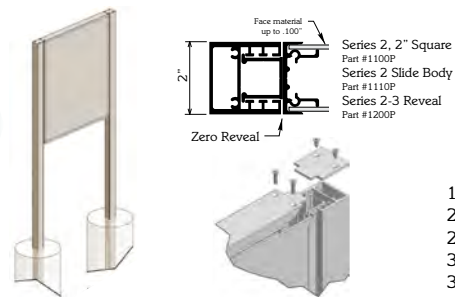

- Series 2 Kits Include:**
- Pre-painted Dark Bronze exterior finish.
 - Two (2) 95-3/4" Series 2, 2" Square Posts.
 - Series 2 Slide Body will accept composite or solid face material.
 - All hardware required for assembly.

12 x 24.....	\$274	36 x 60.....	\$325
24 x 24.....	285	36 x 72.....	335
24 x 36.....	295	48 x 48.....	325
36 x 36.....	304	48 x 60.....	335
36 x 48.....	315	48 x 72.....	345

Series 3

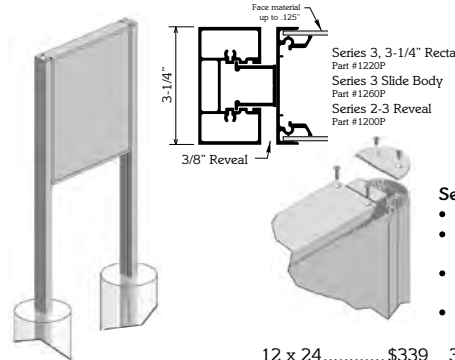

- Series 3 Kits Include:**
- Pre-painted Dark Bronze exterior finish.
 - Two (2) 95-3/4" Series 3, 3-1/4" Rectangular or Radius Posts.
 - Series 3 Slide Body will accept composite or solid face material.
 - All hardware required for assembly.

12 x 24.....	\$339	36 x 36.....	\$370	48 x 48.....	\$399
24 x 24.....	355	36 x 48.....	384	48 x 60.....	413
24 x 36.....	370	36 x 60.....	399	48 x 72.....	428

Series 2-3 Panel Adaptors

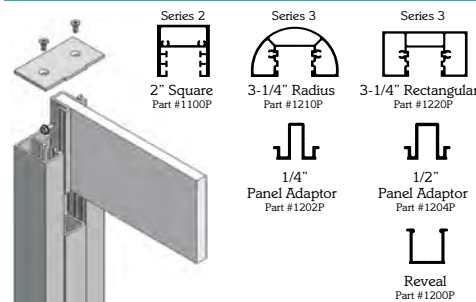

- Panel Adaptor Kits Include:**
- Two (2) 95-3/4" Cut to size posts.
 - Two (2) Slightly oversized caps with screws.
 - Full Panel Adaptor or cut-to-size Panel Adaptor.
 - Screws for panel assembly.
 - Cut-to-size reveal for the "below the panel filler". (optional)
- NOTE: The "below the panel filler" is cut to fit 6" below grade.

Series 2, 2" Square Post
 Two (2) 95-3/4" posts & caps - \$223.00
 For 9', 10', & 11' post lengths - Add \$16.00 per ft. per post
 Two (2) - 143-7/8" posts & caps - \$323.00

Series 3 - 3-1/4" Posts Radius & Rectangular
 Two (2) - 95-3/4" posts & caps - \$241.00
 For 9', 10', & 11' post lengths - Add \$18.00 per ft. per post
 Two (2) - 143-7/8" posts & caps - \$353.00

Environmentally Friendly
 LEED Compliant
 Products • Processes • Facility

Wall Mount Retro Frame

- Available in millfinish only.

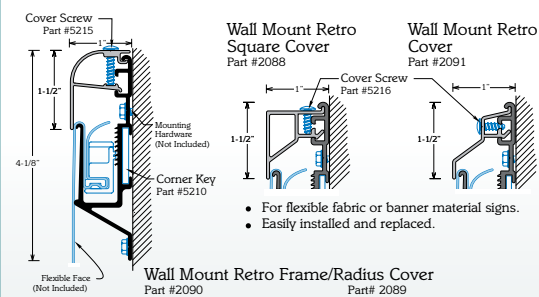
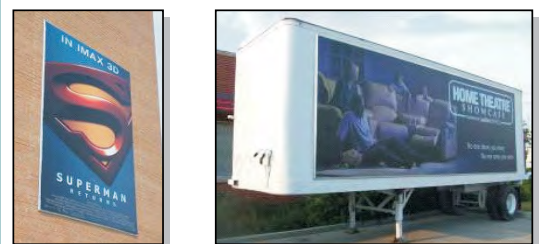

- Kits Include:**
- Four (4) pieces of cut to size and mitered Wall Mount Retro Frame, Part #2090.
 - Four (4) pieces of cut to size and mitered Wall Mount Retro Cover, Part # 2088, 2089, or 2091.
 - Four (4) Corner Keys.
 - Cover Screws.
 - Tension Clips.
- Not Included in Kits:**
- Mounting Hardware.
 - Flexible Fabric.
 - Wall Mount Tension Tool.

CALL US TO ORDER WALL MOUNT FRAME

CALL US TO ORDER POST & PANEL KITS
 Mill finish available at a reduced price for post and panels.

Banner Stands

Premium Retractable Stands

Our highest quality retractable stand.

PREMIER A premium, single-sided cassette banner with ratchet graphic tensioner, direct-to-roller graphic mounting, and dual gripper/self-adhesive slide-in top rail. EVA molded carrying/storage bag included.

PRMR 31.5"W x 29.5 to 83.375"H** \$260.00

PREMIER-2 Same as the Premier, but double-sided

PRMR-2 31.5"W x 29.5 to 83.375"H** 350.00



PINNACLE A premium quality, single-sided banner stand with refined styling, a graphic tensioner, a sleek profile & quick change graphic system. Padded carry bag included.

PINN 31.5"W x 29.5 to 83.4"H* .. \$215.00

PINNACLE-2 Same as the Pinnacle, but Double-sided

PINN-2.... 31.5"W x 29.5 to 83.4"H** ... 270.00

Affordable Retractable Banner Stands

Our most popular, best-selling banner stand!!!!
Why? It's that hot!

MERIT



Quick and simple to use, the Merit combines elegance with excellent value. Finished in anodized Silver with heavy duty molded end plates. Padded carry bag included.

MERIT 31.5"W x 83.4"H* \$140.00



MERIT-2

Same as the Merit, but double-sided!

MERIT-2 39.25"W x 83.4"H* 185.00

* Indicates (+ 6" bleed) ** Indicates (+ 12" bleed)



Scrolling Banner!!!

Unique, Attention Getting
Scrolling Motorized Banners.



REVOLVER FLOOR MODEL

Twin telescopic arms allow you to set the height of your display from 48" up to 72". The scrolling mechanism at the top offers a wide variety of options for the length and style of your graphic. The Revolver utilizes standard 110v power and comes complete with a carry bag. Graphic size: 28.75"W x 145"H (maximum height of looped graphic).

RVLVR..... 31.5"W x 83.4"H \$160.00

Telescopic Banner Stands

2-way telescopic poles (horizontal & vertical)

UNIVERSAL

The Universal system can be used as a single or double-sided unit. The dual telescopic poles (horizontal and vertical) allow the user the option to present banner graphics from a visual minimum of 52.5 wide" up to 95" wide and from a visual minimum of 36" high up to 96" high. Available in Silver or Black. Comes complete with a carry bag.



UNI-S Silver finish \$145.00

UNI-B Black finish 145.00

UNIVERSAL MINI

27.5" to 48"W x 36.5" to 96"H

UNIMINI-S Silver finish \$125.00

UNIMINI-B Black finish 125.00



Economy Display Products



Retractable

INNY-OUTY 1

- Silver (bag included)
- Aluminum anodized body
- Twin stabilizing feet

IO-1 \$54.95

INNY-OUTY 2

- Single Side Roll Up
- Aluminum anodized body
- Twin stabilizing feet
- Silver or Black
- Padded Bag included (area, 33.5 x 78.7")

IO-2 \$57.36

INNY-OUTY 3

- Single Sided Roll Up
- Aluminum anodized body
- Adjustable height pole
- Silver or Black
- Padded Bag included (area 33.5" x 90.6")

IO-3 \$63.75



Telescopic

EXPANDER 1

- Lightweight,
- Double-sided
- Swivel-out feet, silver (area 23.5 x 36-70")

EXP-1 \$41.50

EXPANDER 2

- Full telescopic pole
- Black and silver finish (area, 38.75 x 78")

EXP-2 \$64.50

EXPANDER 3

- Double-sided
- Full telescopic pole
- Black and silver finish (area, 38.75 x 78")

EXP-3 \$77.50

EXPANDER 4

- Stylish cast aluminum foot
- Polished silver finish (area, 31 x 78")

EXP-4 \$75.50

Spring

SPRING 1

- Lightweight, carbon fiber

SPRING-1-MIN 24 x 78.5" \$35.95

SPRING-1-MAX 35.25 x 78.5" \$36.95

SPRING 2

- Anodized Aluminum finish (bag included)

SPRING-2 27 x 78.5" \$39.50

SPRING 3

- Lightweight, carbon fiber
- Double-sided presentations

SPRING-3 27.5 x 70.75" \$42.95

SPRING 4

- Carbon & Aluminum construction

SPRING-4 31 x 64.125" \$39.95



Portable Banner Stands

The Perfect Solution for Trade Shows

- Portable, light-weight design for painless transport
- Sets up in seconds, so easy a monkey could do it!



Mini-Pod *Image/Impact*

- 8.5" x 17" Counter-top unit (rec. banner size, 8.5" x 15")
- Easy to use with "0" grommets
- Banner just slides on
- One piece – assembles in seconds
- Comes with carrying bag.

MINI-POD 1-24 \$9.95 each
25+ 8.50 each

Mini-Inny-Outy

- Retractable tabletop banner stand
- Great attention getter!
- Available in Silver.
- Size: 4" x 2" x 10",
Graphic Height: 11.5" + bleed
Graphic Width: 8.125"

MINI-IO 1-24 \$17.95 each
25+ 15.50 each



Trade Show Displays

Tension Fabric Systems

Sets up in under 5 minutes!

POPOP PORTABLE DISPLAY

A light weight, heavy duty frame that can suspend a fabric graphic mural. It sets up in seconds and can be packed away just as quickly! 90x90" shown. Available in other sizes! The frame comes with a full fitted front graphic and a bag.

.....CALL FOR SIZES & PRICING



Multi-Option Backwall Display

NEW Versatile Product

AERO GRAPHIC DISPLAY KIT

Indoor/outdoor modular display system. Adjustable heights and angles allow for a variety of advertising and display possibilities. Kit includes 2 light fittings and bags. Floodlights sold separately.

.....CALL FOR SIZES & PRICING



Our Best Selling Portable Display

Case Turns into a Stand

COYOTE CURVED POPUP

Coyote 4x3 kit with a curved frame. The Coyote popup display system combines strength and reliability with style and ease of use. The 4x3 curved kit is 87.5625" high and 118" wide including end caps. The footprint is 118"x 36.5" deep.

.....CALL FOR SIZES & PRICING



Literature Rack

Our Best Selling Stand

LITRACK 1 COLLAPSIBLE STAND

The same great features as the Zedup 2 in a single width unit. Available in textured Black or high shine Silver. A soft carry bag is included (hard case available).

ZedUp 1 single width in Black:

LR-1-B..... \$219.95

ZedUp 1 single width in Silver:

LR-1-S..... 219.95

Hard case:

LR-HC 75.00



LIGHTS! NEED DISPLAY IDEAS? CASES!

Call Aksarben Sign & Graphic Supplies and we'll try to find the right trade show display for you. Don't see it here? Ask us for more options!

TEMPLATES!



TileMaster Fills

TileMaster is unique because it's the original seamlessly tileable fills product that prints at a high resolution. 30" X 30" @ 100dpi (creation scale) so you know it'll make you look your best. TileMaster can be installed directly into the fills palette of most all sign making or illustration software including Adobe Photoshop. Two clicks and TileMaster tiles out to the size you need, when you need it.



Only \$285 **\$256**



Monster Wrap Fills

Monster Wrap fills are unique because they tile seamlessly in all directions! This means total control over scale without losing control over resolution. And, you know you'll get that legendary quality that Aurora is known for. DVD only, High quality .jpg and layered .eps hardware images included.



Only \$399 **\$359**



Wrapture Volumes



Wrapture Full Vol. 1

Resolution so precise you'll be putting painters out of business overnight. Huge gradients and sweeping, graceful designs that are sure to please everyone, DVD only.

Only \$299 **\$269**

Wrapture Full Vol. 2

High-resolution 3D images that average 222" X 88" for flawless printing. Blow these images up 200% to 300% with little degradation of the image, DVD only.

Only \$299 **\$269**

Wrapture Full Vol. 3

Our latest series of breathtaking, super high-resolution 3D digital images. Your quality will be top-drawer... High resolution .jpg format, DVD only.

Only \$299 **\$269**

Wrapture Half Vol. 1

Partial wrap design collection are large (average is 200" long) with cutcontour included! High rez .tiff and .eps format, DVD only.

Only \$299 **\$269**



Digital Firestorm

Add any of the 116 transparent .tiff flame images to your work and watch it sizzle! Also included are 17 bonus flames that have a solid black background. Choose from side flames, rocker panel flames, hood flames & more. (also comes in multiple color combinations for that really custom look) jpg format, DVD only.



Only \$299 **\$269**



Wrap Wizard

All new impressive 2 DVD set of backgrounds and design elements for wrapping vehicles—comes in high resolution ensuring perfect prints each and every time! Choose from several ripped images to peeling metal, barbed wire, metal finishes, tubing, gears, chain, razor wire and much much more.



Only \$599 **\$539**

Digital Skullz NEW from Aurora

A variety of different skull images from venomous snakes mid-strike to the Grim Reaper himself. These skullz come in transparent .tiff format for easy use in Photoshop as well as in .jpg format with a workpath included. This title is also perfectly matched to work seamlessly with the Firestorm and Wrap Wizard.

Only \$349 **\$314**



Digital Flags NEW from Aurora

Digital Flags' wave is the same on each flag so you can blend images and still maintain a nice smooth roll. Created at 222" long these babies are perfect for wide format printing. Cut contour supplied on the disk for easy masking mask. Bonus Eagles are included in transparent .tiff format for the ultimate patriotic look.

Only \$349 **\$314**



Print Craft SUITE

A turn-key solution for digitally printed signs, decals and more. This DVD contains 500 print & cut ready sign blanks that are simply beautiful! 3D effects, shadowing and highlights are already designed into the sign blanks for a realistic 3D appearance. Vector cutpath files are included for a flawless in-registration contour cut every time.

Your best choice for digital printing signs, banners, graphics and more! Print Craft Pro Fills allows the user to put textures and backgrounds into your design work that'll make it sizzle! 329 fills on a single DVD includes Diamond Plate, Brushed Aluminum, Engine Turn, Wood, Water, Grass, Storm Clouds, Lightning, Flowers, Flames, Carbon Fiber, Alien Surfaces, Cracked Concrete, Stone, Rocks, Cow Hides, Tiger Hide, Sunsets, Horizon Sky, Bricks, Barbed Wire, Camo, Hardware and MORE! You won't believe what these fills can do for your digital printed images.

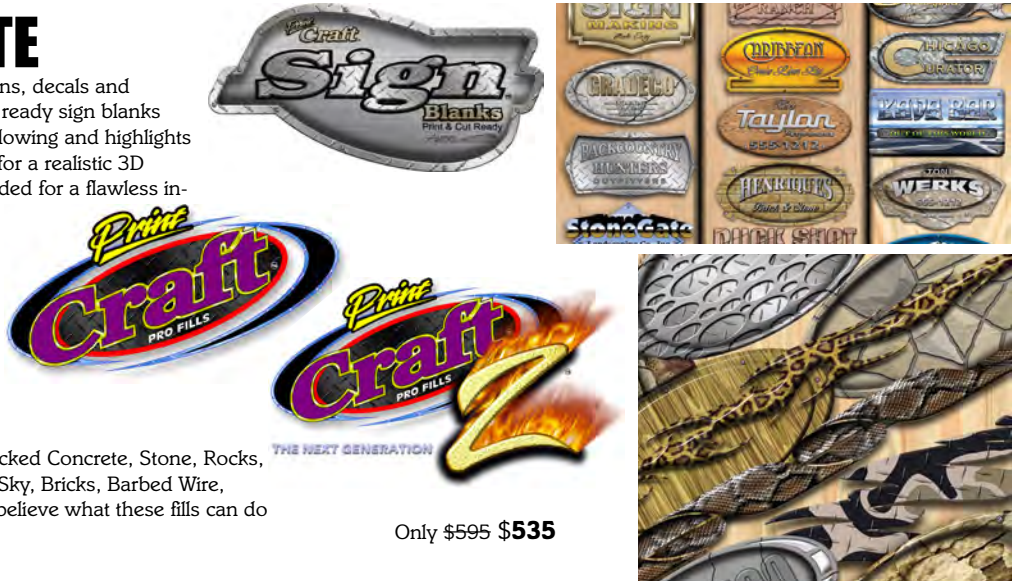

Only \$595 **\$535**

Millennium Edition GOLD

Millennium Edition GOLD!

The graphic pinnacle for which all other collections are measured is now available as a bundle special. 6 Volumes of premium designs by industry veteran Dave Dorsey are included in this superior product which includes 80 color .jpg pictures, 600 fully vectorized vehicle graphics in two formats, and a striping & graphics price guideline. A 52 page full-color bound book included.

Only \$299 **\$269**

Platinum Edition

PLATINUM Edition

Platinum Edition! by Aurora Graphics is a superb choice collection of excellent graphic perfection. These graphics will out-sell all other competitive graphic collections that only try to emulate our years of experience in high-end vehicle art. Don't skimp where it really counts, insist on the very best money can buy...

Only \$395 **\$355**

3-D Print & Cut Magic. 3D METAL MACHINE.

3D Metal Machine

3D Metal Machine! by Aurora Graphics is a great addition to your digital printing equipment. Print & Cut in registration 30 shapes in 242 effects including a realistic "Ripped Metal" image that's very cool! Also included are 150 full color .jpg photos for advertising or display purposes, and a full-color sales / reference book. A must-have for digital printing vehicle graphics with cutting edge effects!

Only \$199 **\$179**

Raven



Raven 3D Print & Cut Magic is a great addition to your digital printer! Print & Cut beautiful vehicle graphics with ease. .tiff and .eps formats are usable with all* signmaking software, while the .plt files open directly into Gerber Advantage & Omega. Full color sales / reference book included. 20 shapes in 127 different effects. Available with the Graphic Design Suite only.

Only \$180 **\$161**



Graphic Design SUITE

You'll receive volumes 1 through 6 (Millennium Edition GOLD) and the Platinum Edition (volumes 7 thru 12) of the classic "Custom Vehicle Graphics" line up, the complete Raven 3D Magic print and cut images, all the Duo Chrome print & cut image collection as well as the entire 3D Metal machine print and cut collection...all at an unbelievable price! So if you are cutting vinyl! or print and cutting, we have the right graphics for you in this heavy weight professional graphic action pak. PLUS, you'll save even more than ever before: Get 'em all and save BIG! Act now before our boss wakes up and realizes he's giving away the farm!

Only \$495 **\$445**

Clip Art Tomm Toons Vol 1

- Over 250 pieces of royalty free images.
- Holiday, classic automobiles & lovable cartoons to unique display text and more.
- Easy to navigate interface to browse the CD.
- Three formats: JPG, EPS & AI.

TOMMTOONS-V1..... CD \$25.00



DIGITALDESIGNWARE

Products Description/Content Price

CAR 'N TRUCK/PRO VEHICLE OUTLINES

2009 Basic

3 DVD set Car 'n Truck / Pro Vehicle Outlines 2009 Totally 41,000 + vehicle templates +365 days updates for vehicle templates \$299

2009 3D

3 DVD set Car 'n Truck / Pro Vehicle Outlines 2009 Totally 41,000 + vehicle templates; 3D Designer-Software + 365 days updates for vehicle templates 365 days updates for 3D model..... \$599

VEHICLE GRAPHICS

Classic Edition v1	CD w/175 graphics incl. poster	\$49
Flaming Animals v1	CD w/100 graphics incl. poster	49
Hot Flames v1	CD w/300+ graphics incl. poster	49
Hot Flames v2	CD w/255 graphics incl. poster	49
Power Edition v1	CD w/1000+ graphics incl. poster	49
Print 'n Cut v1	CD w/50 high-res printable graphics	49
Race Pack v1	CD w/400+ graphics incl. poster	49
Smash Edition v1	CD w/700 graphics incl. poster	49
Street Race Graphics v1	CD w/210 graphics incl. poster	49
Street Race Graphics v2	CD w/150 graphics incl. poster	49
Tribals v1	CD w/151 graphics incl. poster	49
Tribals v2	CD w/179 graphics incl. poster	49
Tribals v3	CD w/151 graphics incl. poster	49
Big Pack	All Vehicle Graphics	299

PRINT 'N WRAP

Full Wrap Graphics.....	DVD w/27 high-res Full Wrap Images ...	\$199
Full Wrap Graphics v2.....	DVD w/27 high-res Full Wrap Images	199
Full Wrap Graphics v3.....	DVD w/27 high-res Full Wrap Images	199
FX Flames	DVD w/525 high-res printable Flames	199
Ghost Flames	CD w/125 high-res transparent Flames.....	79
Skylines	DVD w/27 high-res N.American Skylines	199
Tiles & Textures	DVD w/140 high-res tiles & backgrounds	199
Wild Fire	DVD w/25 realistic flame images	199
Print 'n Wrap Bundle	All 8 Print 'n Wrap Products	999

DIGITAL ART

Monster Skulls	CD w/50 skulls and boneheads	\$49
Motor Sports	CD w/50 race-oriented vector files	49
Pin Ups	CD w/25 high-class pin up images.....	49
Pin Ups v2	CD w/25 high-class pin up images.....	49
Scary Skulls	CD w/75 skulls and boneheads	49

SIGN PRODUCTS & FONTS

Sign Design Concepts	CD w/30 editable company logos	\$79
Sign Design Graphics	CD w/150+ sign design elements	49
Safety Signs	CD w/1600+ vinyl-ready standard signs ...	49
Traffic Signs	CD w/1100+ vinyl-ready standard signs ...	49
Signmaker's Fonts	CD w/5 Chisel-Fonts.....	49
Signmaker's Fonts v2.....	CD w/5 Chisel-Fonts.....	49
Singleline Fonts	CD w/17 singleline engraving fonts	79
Sign Design Bundle.....	All Sign Products & Fonts	199

VOLUME 1

ANTIQUE PANELS and ORNAMENTS (378 Images)	BORDERS (671 Images)
CARTOONS (597 Images)	FIRE ENGINE, POLICE AND EMERGENCY (260 Images)
HAND LETTERED ALPHABETS (806 Images)	GREAT AMERICAN PINSTRIPING (564 Images)
ILLUSTRATIONS (878 Images)	ORNAMENTS (564 Images)
DESIGN ELEMENTS AND ACCENTS (668 Images)	VEHICLE GRAPHICS (730 Images)

VOLUME 2

BORDERS (754 Images)	ILLUSTRATIONS (2654 Images)
CARTOONS (512 Images)	ORNAMENTS (702 Images)
GREAT AMERICAN PINSTRIPING (78 Images)	DESIGN ELEMENTS AND ACCENTS (390 Images)
HAND LETTERED ALPHABETS (234 Images) 261	VEHICLE GRAPHICS (546 Images)

VOLUME 3

ORNAMENTS (623 Images)	ILLUSTRATIONS (2,768 Images)
BORDERS (182 Images)	SIGN AND LETTERING CONCEPTS (572 Images)
CARTOONS (512 Images)	OCCUPATIONS (338 Images)
HAND LETTERED ALPHABETS (390 Images)	GREAT AMERICAN PINSTRIPING (104 Images)
	VEHICLE GRAPHICS (156 Images)

Vector Art

Published January, 2000

Published September, 2004

Published April, 2007

6000+ all new images

411 Sign Blanks
594 Street Racers
200 Sign Fills
50 Chalk Art Signs

Mega, Mega 2, Mega 3

The highest quality electronic artwork for the sign industry since 1990.

Mega, Mega 2 and Mega 3 CD Catalog Collections..... **\$299 ea**

Digital Mega Collection

for Large Format Printing. includes over 1200 images, each with a companion "cut" file. 1 DVD-ROM w/hi-res PDF Catalog **\$129**

Software

ErgoSoft v12

ErgoSoft is a developer of high fidelity inkjet RIP software. Each ErgoSoft RIP is uniquely designed to meet the specific requirements of Fine Art, Photography, Large Format Graphics, and Dye Sublimation.

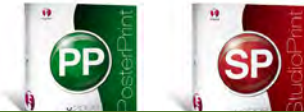

Roland UNIVERSITY

Get on the fast track, call us and find out how.



PosterPrint

The industrial-level solution for color-critical, high quality digital print production.

The promise of high fidelity digital printing is finally realized with PosterPrint. Winning many international awards with its high-end RIP software, ErgoSoft tells a success story where also our customer benefits by using these award winning products.

- Extremely Easy to Use
- Powerful PostScript Interpreter
- Precise Color Reproduction
- Print and Cut
- Scalability
- Color GPS available
- Support of Popular Printers



PosterPrint

POSTERPRINT Call For Pricing

StudioPrint

The digital imaging solution that transforms photographer into professional fine art printmaker.

Whether for Fine Art, Photography, Large Format Display, or Textile, ErgoSoft has a RIP that meets the most demanding requirements.

- Digital Darkroom
- Black and White Print
- Extremely Easy to Use
- Precise Color Reproduction
- Robust Image Layout
- Support of Popular Printers



StudioPrint

STUDIOPRINT Call For Pricing



i1 Design LT

Everything you need to implement a color managed workflow. You'll easily be able

to measure, mix and share spot and PANTONE® colors plus take advantage of a host of other cool design tools.

- Includes **i1Pro** measuring device
- Includes **i1Share & i1Match** Software
- Ambient light measurement for verifying standard conditions
- Easy-to-use, step-by-step software interface—no extra manuals needed

- New “how to video” for scanning test charts and “optical beep” added for even greater usability
- Laptop mode for better, more neutral laptop LCD profiles
- Luminance settings for matching multiple monitors to each other
- Easy upgrade functionality
- Upgradeable to full automation with **i1iO** scanning table
- One push button monitor calibration
- USB powered.
- Carrying case included.

i1DES-LT \$995.00



Color-Checker Chart

24 scientifically prepared colored squares representing common natural objects, helps match colors under any illumination.

i1-CCC \$74.00

ColorChecker Gray Scale

Provides reference values to check and adjust colors, faster and easier.

i1-CCGS \$59.00





SIGNLAB for **VersaWorks™ Edition**

NEW

CADlink Announces New SignLab Product for Roland Users

Maximize the investment you have made in your Roland™ printer.

SignLab now comes configured specifically to work seamlessly with your VersaWorks™ software!



Features & Benefits for Versaworks® Users

SignLab Version 8 is now also available in a new configuration called **SignLab for VersaWorks™ Edition**. Specifically designed for sign makers using VersaWorks™ software to send print, print and cut jobs to their Roland™ printers and Print and Cut devices.

- Incredible Print, Print & Cut Production Tools!
- Super-size Images
- Best vectorization on the market
- Designed for Print and Cut solutions
- Automatic on screen color management for Versaworks™
- Versaworks™ palette included
- Automatic PDF color management for sending out proofs.
- File > Print to VersaWorks
- Fluid Mask™ (Optional): Incredibly simple masking tool
- Over 75 special effects plug-ins for both vector & bitmap
- Specific photographic image filters
- Complete, professional text composition layout tools including 1100+ fonts
- Instant Replay, automatically apply intricate special effects into your designs
- Plus all the amazing design tools found in our SignLab Print and Cut software package

Be More Profitable!

SL-0800-P-VERSA..... Call for Pricing \$995

Incredible Print, Print & Cut Production Tools!

- ✓ Super Size Image: Unmatched tool for scaling up low resolution images for wide format prints.
- ✓ Best vectorization on the market. Super Size image also enables you to take graphics directly off the internet and turn them into crisp vectors literally in minutes.
- ✓ VersaWorks™ palette included: Easy color matching with the VersaWorks™ swatch (also includes built in swatch creation for additional media).
- ✓ Automatic PDF color management for sending out proofs. Customers see the colors you see!
- ✓ File > Print to VersaWorks: Print directly to Queue A or B.
- ✓ Contour cut: Designed for Print and Cut solutions, no complex setup for cutting or setting of cut paths. Try this in desktop publishing software packages.
- ✓ Automatic on screen color management setting for working with VersaWorks™.
- ✓ Fluid Mask™ (Optional add on): Incredibly simple masking tool that easily removes backgrounds or unwanted parts of an image.
- ✓ Over 75 special effects plug-ins for both vector and bitmap images.
- ✓ Complete, professional text composition layout tools including 1100+ fonts.
- ✓ Amazing photographic image filters.
- ✓ InstantReplay, automatically apply intricately created special effects onto new objects/designs.



SignLab version 8

Crossgrades Discounts Available



From its advanced design engine to its enterprise work flows to its e-commerce features that help sign shops connect to their customers SignLab Software is all about Printing and Cutting in the modern sign business.

SignLab Vinyl

SignLab Vinyl is strongly featured design and production sign software dedicated to vinyl cutting.

Suitable for the new or established sign shop that does not need a full time designer – where designer's duties are split between sign and sign assembly.

SL-0800-P-VINYL Call \$1,600

SignLab Vinyl Pro

SignLab Vinyl Pro is the ultimate sign design and production software dedicated to vinyl cutting.

Developed for professional level sign shops with one or more full-time staff designers where interactivity between 3rd party design applications is a must. Manages significant volumes of complex vinyl cut signage, but limited support for in-house printing of signage.

SL-0800-P-VINPRO Call \$2,400

SignLab Print & Cut

The sign industry's only enterprise level design and production software for sign printing and vinyl cutting.

Professional software made for busy shops designing both vector and color raster images, where interactivity between 3rd party applications is important. Get the highest quality from an array of cutters, inkjet, and thermal sign printers with effective production tools to manage large volumes of print & cut signage.

SL-0800-P-PRICUT Call \$3,700

Crossgrades Discounts Available



Flexi™ FAMILY v8.6

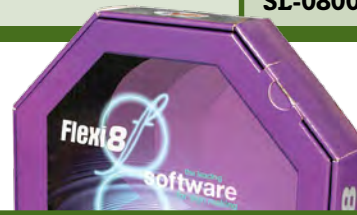

Flexi8

The industry standard for Sign Making software, SAI's Flexi™ Family 8 continues to offer your Sign Making business innovative tools with very profitable results. By integrating finely tuned technology with years of feedback from our Sign Making partners and users, Flexi™ Family 8 maintains its status as the number one choice for dependable, feature-rich Sign Making software with uncompromising quality. **Available for Mac or PC.**

FlexiSIGN-PRO™

The SAI flagship product, offers the total solution for any sign making business.

FSPRO-8 \$4,295

FlexiEXPERT™

This package is designed for the sign maker who requires advanced vinyl cutting and bitmap editing tools without the need for wide format printing output.

FE-8 \$2,495

FlexiPRINT & CUT™

A brand-new design, scanning and tracing software package with complete cutting output.

FPC-8 \$2,295

FlexiSIGN™

This mid-level sign making package provides exceptional tools to produce high-quality signage without a large initial investment.

FS-8 \$1,695

FlexiLETTER™

This entry-level layout and cutting package features file import and export, full text manipulation and direct drivers for the industry's most popular vinyl cutters.

FL-8 \$995

FlexiDESIGNER™

This design program is intended to be used as a second design-only station.

FD-8 \$1295

FlexiENGRAVE™

This program is for the professional sign maker who requires advanced engraving, editing, serialization, color tracing and many other useful features.

OFENG-8W \$795
(add-on option for Flexi 8)



LED Lighting

Efficient and Long Lasting Lighting Solutions



TuffRayz

Our #1 Product!

Wind, rain, ice and humidity are no match for AgiLight's new TuffRayz LED modules. Durable & extremely weather-resistant, TuffRayz provide an affordable, energy efficient channel light solution for indoor and outdoor signage.

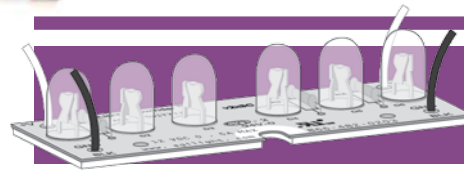

SideWinder Original

SideWinder Originals are constructed with rounded LED's designed to fill the inside cavity with light, and mounts on the side near the back of the can.*

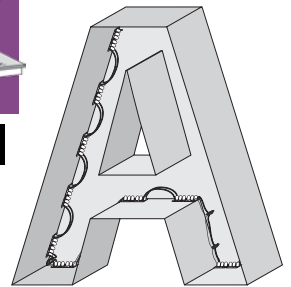

PRODUCT #	DESCRIPTION	PRICE
AGI-TUFFRAYZ-R	TuffRayz Red	\$4.73/ft
AGI-TUFFRAYZ-A	TuffRayz Amber	5.59/ft
AGI-TUFFRAYZ-O	TuffRayz Orange	5.59/ft
AGI-TUFFRAYZ-B	TuffRayz Blue	9.79/ft
AGI-TUFFRAYZ-G	TuffRayz Green	9.79/ft
AGI-TUFFRAYZ-W	TuffRayz White	8.79/ft

PRODUCT #	DESCRIPTION	PRICE
AGI-SW1R050	Sidewinder Orig - RED	\$5.53
AGI-SW1O050	Sidewinder Orig - ORANGE	7.53
AGI-SW1A050	Sidewinder Orig - AMBER	6.65
AGI-SW1G050	Sidewinder Orig - GREEN	10.39
AGI-SW1B050	Sidewinder Orig - BLUE	10.15
AGI-SW1W050	Sidewinder Orig - WHITE	9.31

ThinRayz

At **0.188 inches thick**, ThinRayz's low-profile and ultra-thin form factor allow for even lighting of extremely shallow letters and signs as small as 1.5 inches in depth!

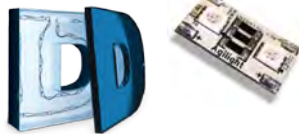
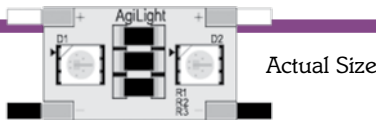

PRODUCT #	DESCRIPTION	PRICE
AGI-SW1RTHINRAYZ	ThinRayz - RED	\$9.59/ft
AGI-SW1ATHINRAYZ	ThinRayz - AMBER	9.93/ft
AGI-SW1GTHINRAYZ	ThinRayz - GREEN	14.92/ft
AGI-SW1BTHINRAYZ	ThinRayz - BLUE	14.52/ft
AGI-SW1WTHINRAYZ	ThinRayz - WHITE	13.19/ft
AGI-SW1WWTHINRAYZ	ThinRayz - WARM WHITE	13.19/ft



SideWinder 165°

SideWinder 165's are constructed with flat LED's designed to disperse the light forward. They mount to the back of the can.*

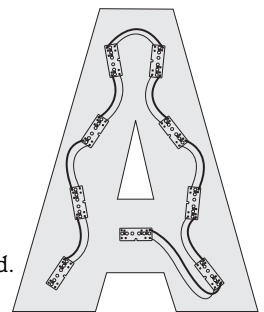

ThinRayz XTRA

ThinRayz Xtra's low-profile and ultra-thin form factor are the same as the ThinRayz, but with twice the lights in each section.



PRODUCT #	DESCRIPTION	PRICE
AGI-THINRAYZXTRA	ThinRayz XTRA - WHITE	16.79/ft

PRODUCT #	DESCRIPTION	PRICE
AGI-SW1R050-V	Sidewinder 165° - RED	\$5.85
AGI-SW1A050-V	Sidewinder 165° - AMBER	6.65
AGI-SW1G050-V	Sidewinder 165° - GREEN	11.72
AGI-SW1B050-V	Sidewinder 165° - BLUE	11.32
AGI-SW1W050-V	Sidewinder 165° - WHITE	10.87

*Adding silicone is recommended with all modules for greater adhesion.

LED Power Supplies



Save money over the life of your signs

PRODUCT #	DESCRIPTION	PRICE
AGI-LP1020-12	Power Supply-20W-12V	\$41.99/ea
AGI-ADV-60W	Power Supply-60W-12V	57.99/ea
AGI-ADV-60W-MULTI/120/277	Power Supply-60W-110/277	82.49/ea
AGI-45W-WP-110/220	Power Supply-45W-desktop	27.98/ea
AGI-USA-4.8W-110/220	Power Supply-4.8W-400MA-12V	9.00/ea
AGI-RI-120W/12V-2C	2-channel, 120W-12V	94.95/ea



800-646-6064

- Lamination
- Equipment
- Ink & Parts
- Services
- Custom Banners
- Vinyl
- Apparel Transfer
- Sign Supplies
- Tapes
- Displays
- Software & Fills
- LEDs
- Electrical
- Substrates

Ballasts

Magnetic HID Ballasts

Advance's SignPRO® line of sign ballasts includes a wide range of options for illuminated sign applications using high intensity discharge (HID) light sources. With special offerings such as F-Can ballasts and core-and-coil ballast kits, Advance's broad HID ballast line offers sign suppliers, manufacturers, and installers a broad range of dependable lighting solutions.

SignPRO is ideal for outdoor venues such as canopies in service stations and parking lots for retail establishments like supermarkets and convenience stores, as well as other applications requiring high intensity discharge (HID) light sources.

- Compact design. Easy to install.
- "72C Series" ballasts feature dual voltage (120/277V) operation and thermal protection for indoor and outdoor use
- Comprehensive kits feature mounting hardware, capacitor, and ignitor componentry. Simplifies

- installation and maintenance
- VAL-U-PAK Plus kits for the most popular Metal Halide and High Pressure Sodium lamps provide a new ballast and top-quality lamp all in one package. Simplifies installation and reduces maintenance/labor costs

CALL FOR DETAILS and PRICING.....

(A wide range of options need consideration – light source, ballast type, kits, etc. – please call for requirements)



Magnetic Ballasts

Advance's SignPRO® magnetic ballasts for T12/HO Rapid Start Fluorescent Lamps deliver the combined benefits of efficient operation, long ballast life, and outstanding reliability. Built to perform under all weather conditions, Advance's family of SignPRO magnetic ballasts offers sign suppliers, manufacturers, and installers a broad range of dependable lighting solutions.

SignPRO is ideal for such applications as backlit signs, channel letters, and building fascias, as well as other applications requiring T12/HO Rapid Start Fluorescent Lamps.

- High-grade steel laminations and vacuum-impregnated copper coils aids heat dissipation and moisture protection.
- Specialized integral anchor tabs. Allows addition of optional customized wiring components

- Corrosion-resistant white-steel casing
- UL Type 2 Outdoor-listed and operation down to -20°F
- UL and CSA-certified. Insures safe and reliable operation

CALL FOR DETAILS and PRICING.....

(A wide range of options need consideration – light source, ballast type, kits, etc. – please call for requirements)

Magnetic Ballast Guide & Specs

Ballast Selection Guide

Number of Lamps per Ballast	Total Lamp Feet																							
	2	4	6	8	10	12	14	16	18	20	22	24	26	28	30	32	34	36	38	40	42	44	46	48
1,2	ASB-0412-12-BL-TP VSB-0412-12-BL-TP																							
2,3,4	ASB-0620-24-BL-TP VSB-0620-24-BL-TP																							
2,3,4	ASB-1224-24-BL-TP VSB-1224-24-BL-TP																							
2,3,4	ASB-2040-24-BL-TP VSB-2040-24-BL-TP																							
3,4	ASB-2432-34-BL-TP																							
4,5,6	ASB-1240-46-BL-TP VSB-1240-46-BL-TP																							
4,5,6	ASB-2448-46-BL-TP VSB-2448-46-BL-TP																							

Magnetic Ballast Specifications

Lamp Data	Min. Starting Temp. (°F)	Input Volts	Catalog Number	Max. Line Current (Amps)	Max. Input Power (Watts)	Open Circuit Volts	Dim.	Wiring Diag.	Weight (lbs.)
1,2	-20°F	120	ASB-0412-12-BL-TP	1.48	175	480	BL-1	21, 39	12
			VSB-0412-12-BL-TP	0.65	175	480	BL-1	21, 39	12
2, 3, 4	-20°F	120	ASB-0620-24-BL-TP	1.12	304	720	BL-1	5, 8, 13	12
			VSB-0620-24-BL-TP	1.12	304	720	BL-1	5, 8, 13	12
2, 3, 4	-20°F	120	ASB-1224-24-BL-TP	2.70	312	785	BL-2	7, 9, 13	14
			VSB-1224-24-BL-TP	1.15	312	785	BL-2	7, 9, 13	14
2, 3, 4	-20°F	120	ASB-2040-24-BL-TP	4.00	472	720	BL-3	5, 9, 13	21
			VSB-2040-24-BL-TP	1.75	472	720	BL-3	5, 9, 13	21
3, 4	-20°F	120	ASB-2432-34-BL-TP	3.30	370	975	BL-4	8, 13	21
			VSB-2432-34-BL-TP	3.30	370	975	BL-4	8, 13	21
4, 5, 6	-20°F	120	ASB-1240-46-BL-TP	3.90	462	720	BL-3	14, 15, 19	21
			VSB-1240-46-BL-TP	1.70	462	720	BL-3	14, 15, 19	21
4, 5, 6	-20°F	120	ASB-2448-46-BL-TP	5.19	604	720	BL-3	14, 15, 19	21
			VSB-2448-46-BL-TP	2.25	604	720	BL-3	14, 15, 19	21

- Total lamp length of each circuit (A) and (B) must not be less than 10 ft. nor more than 20 ft. Circuit (A) is comprised of lamps 1,2. Circuit (B) is comprised of lamps 3,4.
- Total lamp length of each circuit (A) and (B) must not be less than 6 ft. nor more than 20 ft. Circuit (A) is comprised of lamps 1,2,3. Circuit (B) is comprised of lamps 4,5,6.
- Total lamp length of each circuit (A) and (B) must not be less than 12 ft. nor more than 24 ft. Circuit (A) is comprised of lamps 1,2,3. Circuit (B) is comprised of lamps 4,5,6.

Ballasts



Electronic Fluorescent Ballasts



Advance SignPRO electronic sign ballasts offer the solution-energy savings of up to 20% when compared to magnetic sign ballasts. Replacing the magnetic core is an innovative circuit board that delivers the energy efficiency and high reliability.

- Quieter, cooler operation without sacrificing light output.
- Built tough and fully potted.
- Rapid start circuitry promises full-rated lamp life.
- Delivers dependable starting, down to -20°F.
- Fully-warranted for three years.
- UL and CSA certified.



PRODUCT #	DESCRIPTION	SPECS	PRICE
ASB041612EI	ELE SIGN BAL (1-2)	T12/HO 4-12ft 120V	\$63.25
ASB123224EI	ELE SIGN BAL (2-4)	T12/HO 12-32ft 120V	86.75
ASB204846EI	ELE SIGN BAL (4-6)	T12/HO 20-48ft 120V	104.75

Electronic Ballast Specifications

Lamp Data			Min. Starting Temp. (°F)	Input Volts	Catalog Number	Max. Line Current (Amps)	Max. Input Power (Watts)	Open Circuit Volts	Dim.	Wiring Diag.	Weight (lbs.)
No. of Lamps	Lamp Footage										
	Min	Max									
1, 2	4	16	-20°F	120	ASB-0416-12-E	1.46	175	750	BL-1	21, 39	6
2, 3, 4	12	32			ASB-1232-24-E	2.95	350	1000	BL-2	5, 9, 13	8
4, 5, 6	20	48			ASB-2048-46-E*	4.17	490	1000	BL-3	14, 15, 19	10

- * Total lamp length of each circuit (A) and (B) must not be less than 6 ft., nor more than 16 ft. Circuit (A) is comprised of lamps 1, 2. Circuit (B) is comprised of lamps 3, 4. (See wiring diagrams)
- ** Total lamp length of each circuit (A) and (B) must not be less than 10 ft., nor more than 24 ft. Circuit (A) is comprised of lamps 1, 2, 3. Circuit (B) is comprised of lamps 4, 5, 6. (See wiring diagrams)
- *** ASB-2048-46-E will operate (3) 10 ft. lamps. (See wiring diagrams)

Ballast Selection Guide

Number of Lamps per Ballast	Total Lamp Feet																							
	2	4	6	8	10	12	14	16	18	20	22	24	26	28	30	32	34	36	38	40	42	44	46	48
1,2	ASB-0416-12-E																							
2,3,4	ASB-1232-24-E																							
4,5,6	ASB-2048-46-E																							

Transformers



Visit www.signandgraphicsupplies.com for complete information and pricing.

We offer the complete line of Actown Transformers! **Featuring Actown Guardian II**

- Self-regulating transformers
- Operates at full current
- Cannot be overloaded
- Reduces inventory
- Simplify field replacement

Standard Outdoor Transformers

Catalog #	Secondary		Primary VA	Input Amps		PRICE
	Volts	mA		120V	277V	
15025-OG	9,000-15,000	25	375	2.9	N/A	\$103.20
9025-OG	3,000-9,000	25	225	1.6	N/A	86.90

Versamount™ Fully Enclosed Transformers

15025-VMG	9,000-15,000	25	375	2.9	N/A	\$112.20
9025-VMG	3,000-9,000	25	225	1.6	N/A	92.50





Substrates

AlumaCorr™

Aluminum/Plastic Corrugated Sign Panel

Available in 8 colors: White, Black, Bronze, Yellow, Almond, Red, Blue and Green.

- Smooth and Glossy Baked Enamel Finish
- Aluminum Overlay on Both Sides
- Corrugated/Fluted Copolymer Plastic Core
- Rot and Corrosion Free
- UL Recognized Component
- Strong and Durable, yet Lightweight
- Weather Resistant, Great for Outdoor Applications
- Covered by a 10-year Limited Warranty



	Description		1-4 sheets	5-9 sheets	10+ sheets
NAC48-5MSSW	5mm 4'x8' Single Sided	White	\$80.70	\$74.70	\$70.00
NAC48-5MW	5mm 4'x8' Double Sided	White	85.00	78.70	73.75
NAC48-5M+(color)*	5mm 4'x8' Double Sided	Colors	95.10	88.00	82.50
NAC48-10MW	10mm 4'x8' Double Sided	White	99.45	92.00	86.25
NAC48-10M+(color)*	10mm 4'x8' Double Sided	Colors	108.10	100.00	93.75
NAC410-5MSSW	5mm 4'x10' Single Sided	White	100.85	93.40	87.50
NAC410-5MW	5mm 4'x10' Double Sided	White	106.65	98.70	92.50
NAC510-5MW	5mm 5'x10' Double Sided	White	177.00	164.00	153.75
NAC410-10MW	10mm 4'x10' Double Sided	White	123.95	114.70	107.50
NAC510-10MW	10mm 5'x10' Double Sided	White	194.50	180.00	168.75

* Add color code to prefix when ordering:

White - **W**, Black - **BLK**, Almond - **ALM**, Blue - **BLU**, Yellow - **YEL**, Red - **RED**, Green - **GRN**, Bronze - **BRZ**

Nu-Alum®

Aluminum Signage*

- Exterior Grade Plywood
- Aluminum Overlay on Two Sides
- Works with Paints, Inks or Vinyl Graphics.
- UL Recognized Components

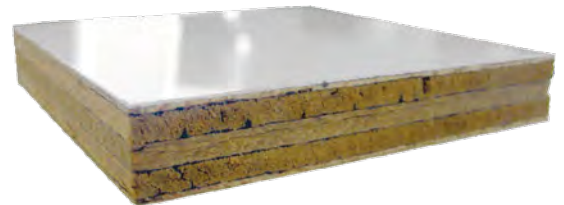

NNA48DSW	1/2"	4x8'	58 lbs	Double Sided	White	\$115.50
----------	------	------	--------	--------------	-------	----------

White Wood®

Smooth White Vinyl (PVC) Laminated Board*

- UV Rated for exterior use
- USDA recognized surface
- Flame-resistant



NWW48-DS	1/2"	4x8'	53 lbs	Double Sided	White	\$103.10
----------	------	------	--------	--------------	-------	----------

Edge Caps

8' lengths available*

- UV Rated for exterior use

	NU-161-W	5mil - White	\$2.85		NU-161-G	5mil - Green	\$2.85
	NU-161-K	5mil - Black	2.85		NU-161-A	5mil - Almond	2.85
	NU-161-R	5mil - Red	2.85		NU-165-W	10mil - White	\$2.85
	NU-161-B	5mil - Blue	2.85		NU-115-W	1/2" - White	3.30
	NU-161-Y	5mil - Yellow	2.85				



ODD CUT SIZES? CALL FOR PRICING
Custom cut sales are final and cannot be returned.

Poly-Metal™

2-sided Aluminum Sign Panel*



- Factory applied protective film is easy to remove guards against scratches, scuffing, and dirt prior to applying vinyl lettering or paint
- Aluminum laminated on both sides for strength and panel rigidity
- Smooth aluminum surface with white baked enamel wax-free finish
- No surface prep required
- No edge caps or edge treatment required
- Excellent for vinyl letters and graphics, inks or paints
- Reusable - change vinyl graphics with little or no ghosting
- Resists scratching and denting better than MDO, wood core panels and corrugated plastic cores
- Strong, durable, lightweight panel (32lbs.)
- Extruded high density polyethylene core
- Easily cuts and routs and can be "v-grooved" for corners and boxes
- Standard black core provides greater UV resistance
- Lifetime warranty on bond line & 10 year overall warranty

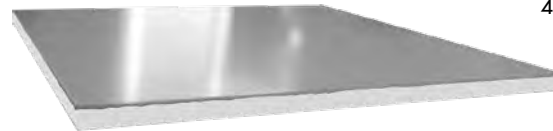

Available Sizes:
4' x 8', 10' Panels

NPM410-3MDSW	3mil	4x10 Double Sided White	\$70.75
NPM48-3MDSW	3mil	4x8 Double Sided White	54.50
NPM48-3MSSW	3mil	4x8 Single Sided White	50.00
NPM48-3MDSB	3mil	4x8 Double Sided Black	64.30

Fiber-Lite®

Smooth Fiberglass Reinforced Plastic Liner*

- White only, .090"
- Gel Coated One Side for Interior / Exterior Use



NFL48-090SSW	1/8"	4x8'.....	53 lbs.....	White.....	\$35.00
---------------------------	------	-------	-----------	-------------	------------	---------

INTEPLAST Corrugate

Corrugated Polypropylene Sheets*



Ultra Smooth 4x8 Sheet, White only.	
COR-4x8-4M-US	4mil \$13.50
4x8 Sheets, White	
COR-4x8-White-4M	4mil 11.99
4x8 Sheets, Black, Clear, Dark Blue, Green, Ivory, Light Blue, Orange, Red, Yellow	
COR-4x8-(Color)-4M	4mil 13.00
4x8 Sheets, White	
COR-4x8-White-10M	10mil 25.80
4x8 Sheets, Block Out White	
COR-4x8-BOWHT	4mil 13.00

HOT ITEM

Flute direction
List width first

Corrugate Sign Blanks

Popular pre-cut sizes. Super choice for quick or temporary signage.

CAT#	SIZE*	COLOR	EACH	CASE/100
COR-18x24-W	18"x24"	White Only	\$1.43	\$95.00
COR-24x18-W	24"x18"	White	1.43	95.00
COR-36x24-W	36"x24"	White	2.70	N/A
COR-24x18-Y	24"x18"	Yellow	1.43	95.00
COR-36x24-Y	36"x24"	Yellow	2.70	N/A

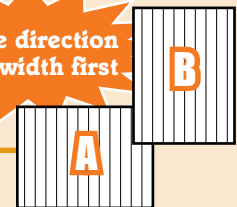

Need something you don't see in this catalog? Call today to find out how we can help.



ODD CUT SIZES? CALL FOR PRICING
Custom cut sales are final and cannot be returned.

Aluminum

Precut Sign Blanks & Full Sheets Available

Brite-White Precut Sign Blanks

• Precut Sign Blanks with Rounded Corners Available

.040 Aluminum

	SIZE	1-9 Q	10+ Q
AL624BW040	6" X 24"	\$2.05	\$2.05
AL628BW040	6" X 28"	2.50	2.50
AL636BW040	6" X 36"	2.90	2.90
AL1218BW040	12" X 18"	3.40	2.99
AL1824BW040	18" X 24"	5.75	5.10
AL2028BW040	20" X 28"	8.15	7.20
AL2436BW040	24" X 36"	11.65	10.30
AL1218BW040-RC	12" X 18"	3.80	3.40

(with Rounded Corners)

.063 Aluminum

	SIZE	1-9 Q	10+ Q
AL1218BW063	12" X 18"	\$5.00	\$4.45
AL1824BW063	18" X 24"	8.95	7.90
AL2436BW063	24" X 36"	18.30	16.25
AL1218BW063-RC	12" X 18"	5.50	4.95

(with Rounded Corners)

.080 Aluminum

	SIZE	1-9 Q	10+ Q
AL1218BW080-RC	12" X 18"	\$6.50	\$5.75

(with Rounded Corners)











Colored Aluminum Sheets

• 4x8 Available in .040, .063, .080 thicknesses*

4 x 8' Aluminum Sheets*

	Description	1-4 Q	5-9 Q	10+ Q
 AL48BW	.040 Brite White	\$68.45	\$63.60	\$59.25
 AL48BW063	.063 Brite White	107.70	100.00	93.45
 AL48BW080	.080 Brite White	136.95	127.15	118.65

4 x 10' Aluminum Sheets*

	Description	1-4 Q	5-9 Q	10+ Q
 AL410BW	.040 - Brite White	\$85.40	\$79.30	\$74.00
 AL410BW	.063 - Brite White	134.65	125.00	116.70
 AL410MB	.040 - Matte Black	89.25	82.90	77.40
 AL410RB	.040 - Raven Black	89.25	82.90	77.40
 AL410CB	.040 - Chevron Blue	89.25	82.90	77.40
 AL410IG	.040 - Ivy Green	89.25	82.90	77.40
 AL410HR	.040 - Hunter Red	89.25	82.90	77.40
 AL410CY	.040 - Caution Yellow	89.25	82.90	77.40
 AL410BY	.040 - Bright Yellow	89.25	82.90	77.40
 AL410BR	.040 - Bright Red	89.25	82.90	77.40
 AL410BG	.040 - Bright Green	89.25	82.90	77.40

PVC Foam Board*

Sturdy, Lightweight Plastic Sheets

- Expanded PVC foam board with a matte finish.
- Lightweight, durable, chemical resistance, fire retardant capabilities.
- Excellent substrate for point-of-purchase displays and signs, and is the substrate of choice for screen-printing and digital printing. Features a consistently smooth and abrasion resistant surface for easy paint and excellent ink adhesion produces sharp, vivid colors – a printed image of superior quality!
- When using vinyl lettering, the bonding is excellent due to the molecular reaction (vinyl to vinyl) between the lettering and the InteFoam® surface.



INTEPLAST

- It can be thermoformed and has a variety of applications in sign, marine, and graphic arts industries. Can be heat bent, routed laminated, pressure or vacuum formed in a variety of shapes and configuration for those challenging displays shapes or promotional material.

4' x 8' Sheets (priced per sheet)

PVC4x8BK3	3mil (1/8") Black	\$30.00
PVC4x8W3	3mil (1/8") White	28.00
PVC4x8W12.7	12.7mil (1/2") White	135.00

ODD CUT SIZES? CALL FOR PRICING
Custom cut sales are final and cannot be returned.





AKSARBEN

Sign & Graphic Supplies

Index

A

Adhesive Remover 44
 A-frame 52, 53, 57
 Aluminum 73
 Angle Iron 56
 Apparel Transfer 41, 42
 Application Fluids 44
 Application Tools 45
 Aqueous Inks 27

B

Backlit Material 5
 Ballasts 69, 70
 Banner 3, 6, 7, 10, 11, 34, 35
 Blanks 35
 Block Out 35
 Custom 34, 35
 Ready Roll 35
 Banner Stands 59, 60
 Banner Ups 49
 Blades 30, 47
 Blockout 3, 7, 10
 Blower/Dryer Kits 23
 Boxes 75

C

Canvas 6, 10, 11, 13
 Capping Tool 26
 Cap Top Assembly 26
 Car Window Clip 57
 Cleaning Cartridges 26
 Cleaning Fluid 44
 Clip Art 64
 Color Management 65
 Cores 75
 Corrugated Panel 71, 72
 Custom Banners 34, 35
 Cutter Bars 46
 Cutter Protection Strips 26
 Cutting Mats 47
 Cutting Tools 46, 47

D

Digital Media 3
 Dust Removal 48
 Dye Sublimation 27

E

Edge Caps 71
 Engraver 25

F

Fabric 13

Fills 62
 Film 5, 6, 10, 11, 14
 Flanges 26
 Flexi 67
 floor 14
 floor graphics 12
 Floor Rack 49
 Foam Board 73
 Foam Tape 51
 Frog Juice 15

G

Grommet Machine 45
 Grommets 45
 Grommet Services 31

H

Hangers 57
 Heat Press 43
 Heat Welder 48
 Hem Tapes 51
 Hobby Knife 48
 Hook & Loop Tape 48

I

Inks 27

K

Knife 47, 48

L

Laminated Board 71
 Laminating Machines 18, 19
 Lamination 15
 Film 16, 17
 Liquid 15
 Specialty 17
 Spray 15
 Waterbase 15
 LED 68
 Letter Kit 52, 55
 LiftStick 45
 Literature Rack 61

M

Magnetic 12, 48
 Maintenance 26
 Maintenance Fluid 26
 Marker Board 55
 Markers 55
 Masking Tape 51
 Media Clamps 26
 Media Racks & Baskets 49

Media Take Up Bar 23
 Mesh Unit 23
 Mist Pads 26
 Mounting Hardware 57

O

Overlaminates 6, 16

P

Pantone Color Bridge 48
 Paper 5, 10, 11, 14
 Pencils 48
 Plotter Blades 30
 Positioning Fluid 44
 Post & Panel 58
 Printer/Cutters 20, 21
 Printers
 Accessories 23
 Wide Format 21, 22, 23

R

Ready Rolls 35
 Release Sheets 42
 Retractable Stands 59, 60
 Rivet Brushes 45
 Roller Applicator 45
 Rotary Blades 47
 Rotary Cutters 46, 47
 Round Rod 56
 Rulers 45, 46

S

Scrapers 26
 Sealing Pen 9
 Services 31
 Custom Banners 31
 Equipment Installation 31
 Repair 31
 Training 33
 Sheet Cut Blades 26
 Sheet Cutter 46
 Shipping 75
 Sidewalk Sign 54
 Sign Blanks 63, 72, 73
 SignLab 67
 Sign Panel 71, 72
 Sign Stake 56, 57
 Software 65, 66, 67
 Solvent Inks 27
 Specialty 6
 Squeegee 45
 Static Cling 14
 Strapping Tape 51
 Swabs 26

T

Tape
 foam 51
 Hem 51
 High Bond 51
 masking 51
 strapping 51
 Ultra High Bond 51
 Tear Resistant 10
 Teflon Sheets 43
 Thermal Transfer Ribbon 28, 29
 Tool Holders 26
 Trade Show Displays 61
 Transfer Tapes 50
 Transformers 70
 Translucent Film 38
 Tweezers 48

V

Vehicle Wraps 13, 62, 63
 Vinyl 3, 4
 Calendered 8, 9, 11, 14, 36
 Cast 4, 9, 12, 13, 37, 38
 Clear 4
 Dry Erase 55
 Etched Glass 39
 Fluorescent 39
 Frosted Crystal 39
 Heat Transfer 4, 42
 Reflective 4, 39
 Specialty 40
 Wall 14
 Window 4, 14
 Vinyl Cutters 24

W

Wall 12
 Wall Mount 58
 Window Film 9
 Wind Sign 54
 Wiper 26

Y

Yard Signs 54, 56

Z

ZeroNine Legacy 28, 29
 ZeroNine NexGen 28, 29

Remember, if you don't see it here, call us at **1-800-646-6064...**
 there's a good chance we can order whatever you heart desires.



Boxes and Cores

Need to ship your graphics? You'll need these.

Boxes

Protect your banners for shipping and storage with boxes designed just for banners.

BOX3	7.25 x 7.25 x 38"	\$2.29
BOX4	7 x 7 x 50"	3.00
BOX5	8 x 8 x 60"	3.50

Cores

3" x 74" Core custom cut to whatever size is right for you. Use for take-up devices or just support you banners on a core.

CORE3+(Length)	cut from 74"	\$8.00
-----------------------------	--------------	-------	--------

3" White Plastic End Caps

Use with any standard 3-inch cardboard core tube. (End Cap only, does not include tube)

ENDCAP	3" cap	\$0.39
---------------------	--------	-------	--------

Strapping Tape

General Purpose Filament Tape.

To hold pharmacy cabinet frame together. For reinforcing baker's trays. As a bond breaker in the concrete industry. Palletizing of boxes. Strapping rods, molding, tubes plywood without danger of scratching, staining or damaging. Reinforcing boxes, protecting contents from pilferage. Benefits: Strong, waterproof, high tack, excellent shear, little stretch.

TAPESTRAP-1	24mm (~1") x 60 yd	\$2.25
--------------------------	--------------------	-------	--------



Aksarben Sign & Graphic Supplies is located in Council Bluffs, IA, minutes from downtown Omaha, NE.

Shipping Info

Return Policy

All discrepancies must be reported within 10 working days of shipment. All returns must be authorized. A Return Authorization Number will be issued by Aksarben Sign & Graphic Supplies, Inc. for approved returns. A 25% restocking charge may be applicable.

NO RETURNS WILL BE ACCEPTED WITHOUT A RETURN AUTHORIZATION NUMBER.

Warranty Information

Aksarben Sign & Graphic Supplies makes no warranties, expressed or implied, including, but not limited to, any implied warranty of merchantability or fitness for a particular purpose. User is responsible for determining whether product is fit for a particular purpose and suitable for user's method of application.

Shipping Information

We use standard UPS shipping rates and add a \$3.50 handling charge per order. We are open to N-30 day payment terms upon approved credit.

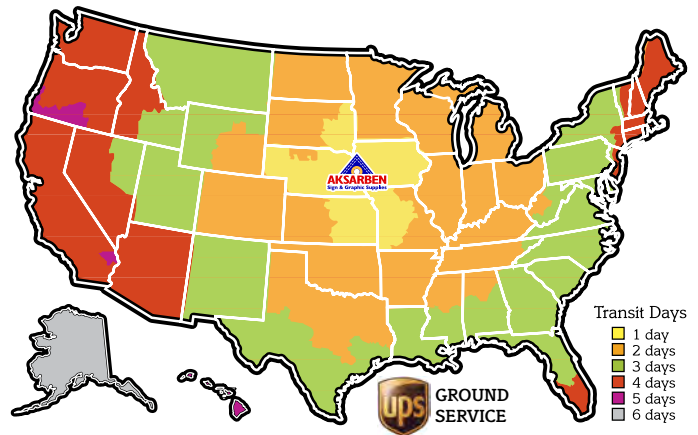

Most orders shipped within 24 hours!



Call today! 800.646.6064



AKSARBEN

Sign & Graphic Supplies

Celebrating over **22 years** in the Industry

www.SignAndGraphicSupplies.com

800-646-6064

Pole Pocket Gauge

